

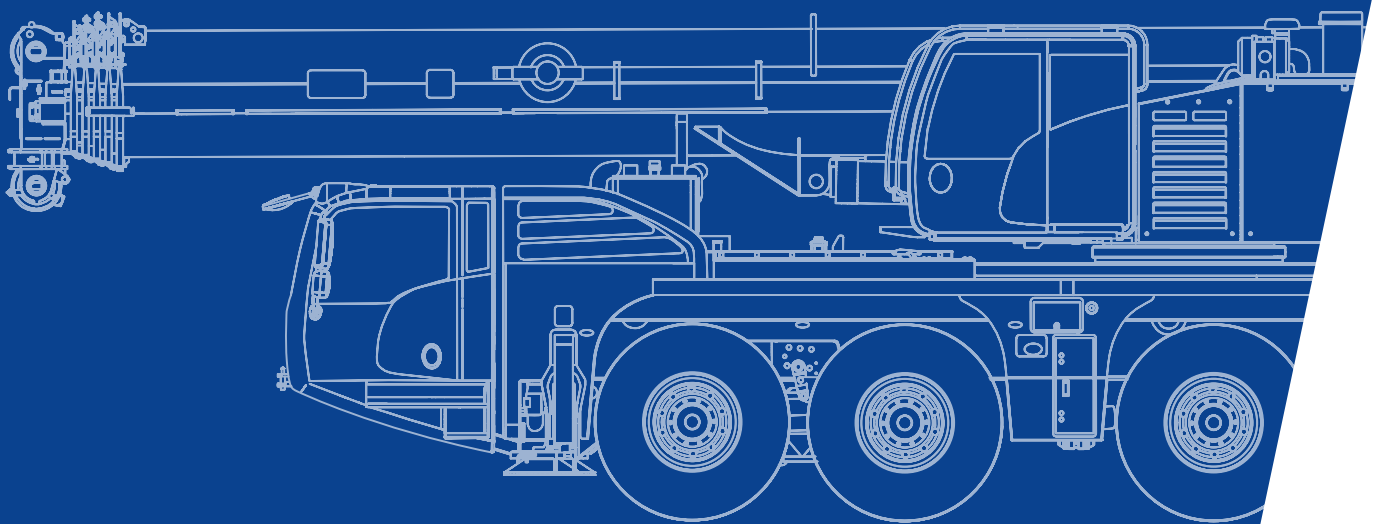

AC 100-4 / AC 100-4 L

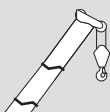

All Terrain Crane
120 USt Capacity class

		Page:
Dimensions.....		4
Specifications.....		6
Equipment.....		7
Counterweight		8
	HA (HA60) Main boom.....	10
	HA (HA50) Main boom.....	38
	HAV (HA60) Folding swing-away jib.....	16
	HAV (HA50) Folding swing-away jib.....	44
	HAV-VA (HA60) Variable extension with swing-away jib.....	22
	HAV-VA (HA50) Variable extension with swing-away jib.....	50
	MS (HA60) Runner	34
	MS (HA50) Runner	62
Technical description.....		66

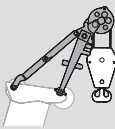
	Counterweight		Slewing
	Lifting capacities on outriggers - 360°		Boom telescoping
	Radius		Boom elevation
	Main boom		Working speeds
	Folding swing-away jib		Max. line pull
	Runner		Rope diameter
	Adapter		Rope length
	Max. axle loads		Hook block (capacity-sheaves-rope diameter)
	Mechanism		Number of lines
	Tires		Possible load of hook block
	Hook block		Weight of hook block
	Hoist		Distance head sheave axle – hook ground
	Dolly		Number of sheaves in boom head
	Travel speed		Supporting force
	Gradeability – road		Length of stroke (support cylinders)
	Gradeability – off road		Additional parts for hydraulic system
	Transport storage HAV at main boom		Payload incl. rear storage box

Dimensions

AC 100-4 / AC 100-4L

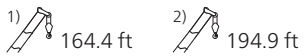
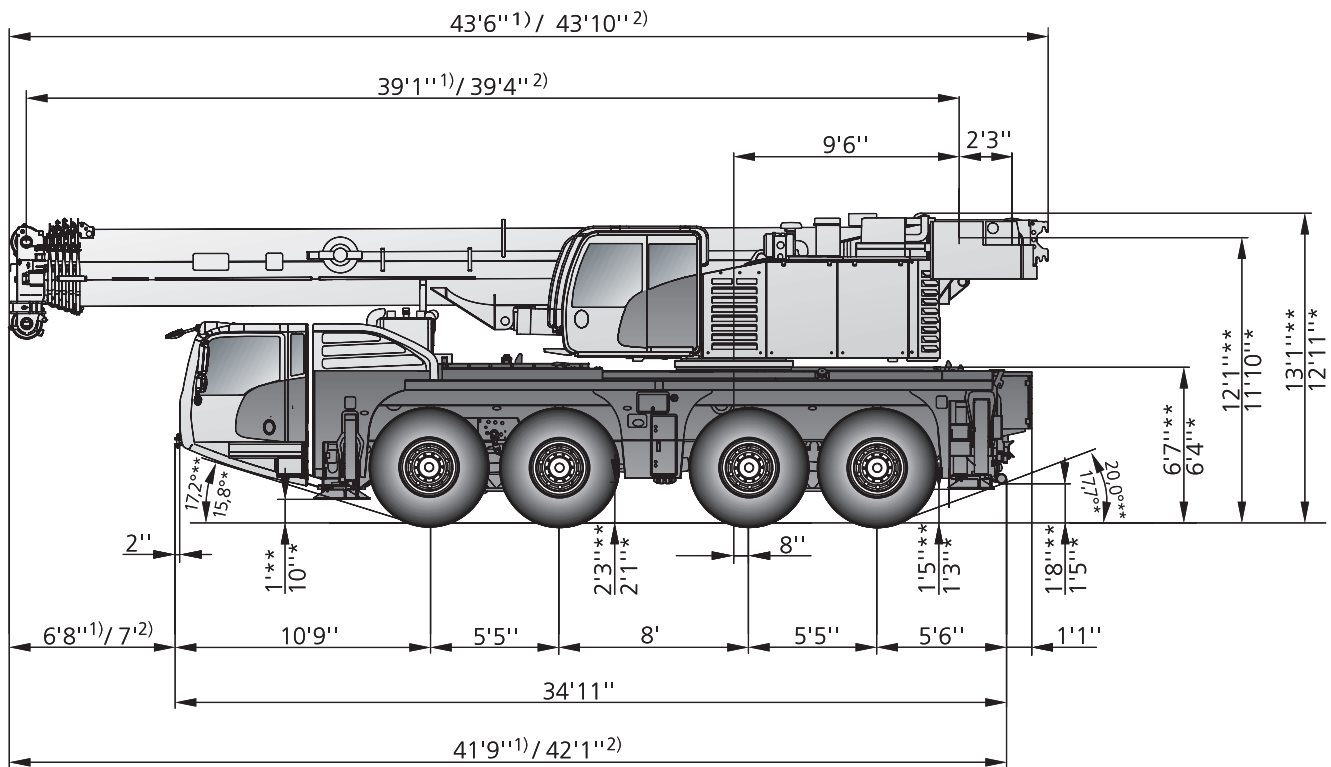

* 385/95 R25

** 445/95 R25 / 525/80 R25

Dimensions

AC 100-4 / AC 100-4L

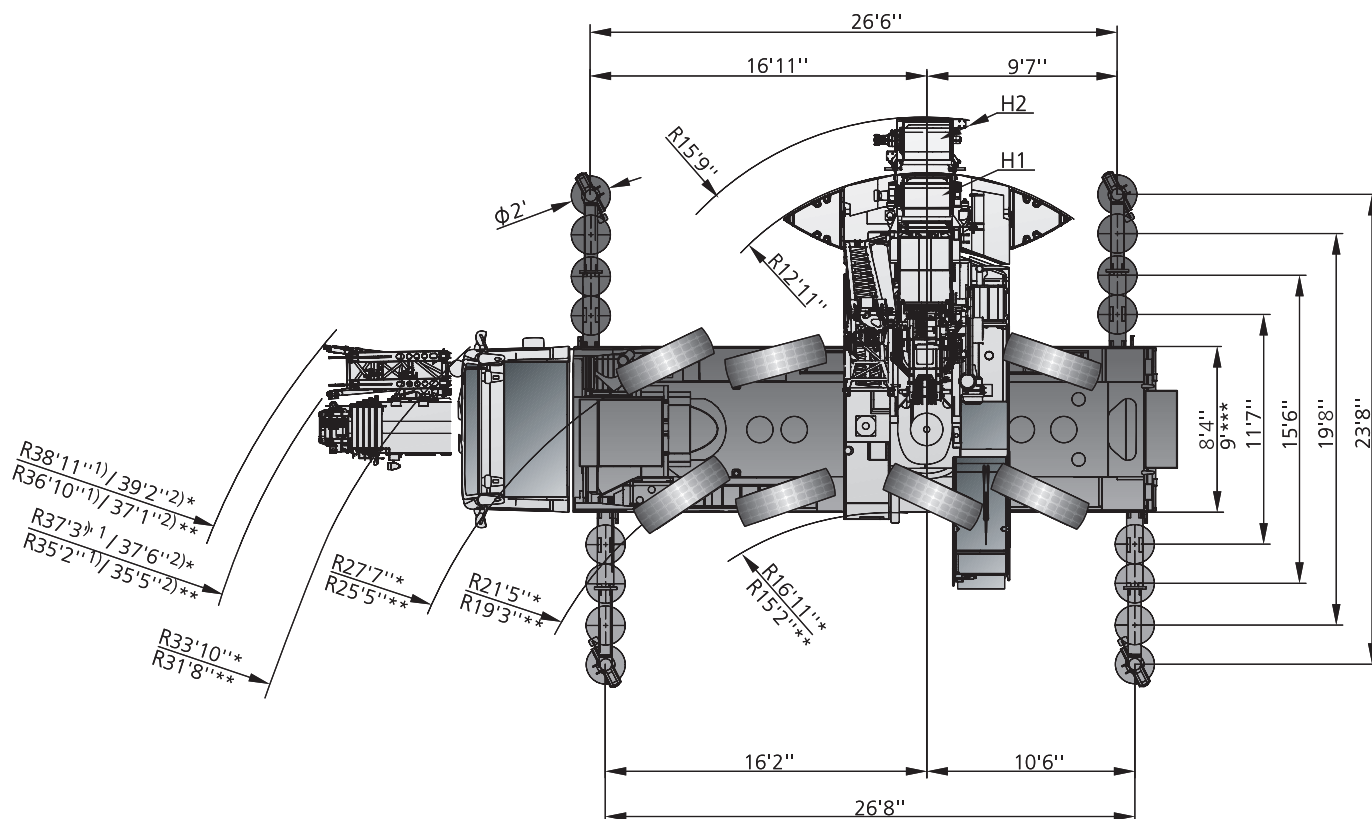

1) 164.4 ft 2) 194.9 ft

* steering mode 2











** steering mode 3

***  525/80 R25

see page 6

Specifications



AC 100-4 / AC 100-4L

													
	Total			TELMA						HA 50	HA 60		
<22,100 lb	on request · auf Anfrage · sur demande · su richiesta · bajo demanda · a pedido · по заявке												X
<26,500 lb	<106,000 lb	8 x 6 x 8	445/95R25	X	8-0-18	13,400 lb	–	X	–	X	–	–	–
<26,500 lb	<106,000 lb	8 x 6 x 8	445/95R25	X	8-0-18	9,500 lb	62.3 ft	X	–	X	–	–	–
<32,000 lb	<117,000 lb	8 x 6 x 8	385/95R25	X	50-3-18	19,000 lb	62.3 ft	X	–	X	–	1,320 lb	–
<36,400 lb	<143,300 lb	8 x 6 x 8	445/95R25	X	50-3-18	42,500 lb	62.3 ft hyd.	X	X	X	–	1,320 lb	–
<26,500 lb	<106,000 lb	8 x 6 x 8	445/95R25	X	50-3-18	9,500 lb	–	X	X	–	X	1,320 lb	–
<26,500 lb	<106,000 lb	8 x 6 x 8	445/95R25	–	8-0-18	9,500 lb	32.8 ft	X	–	–	X	0,660 lb	–
<26,500 lb	<106,000 lb	8 x 4 x 8	445/95R25	X	8-0-18	9,500 lb	32.8 ft	X	–	–	X	0,880 lb	–
<32,000 lb	<117,000 lb	8 x 6 x 8	385/95R25	X	8-0-18	19,000 lb	62.3 ft	X	–	–	X	1,320 lb	–
<36,400 lb	<145,500 lb	8 x 6 x 8	445/95R25	X	50-3-18	42,500 lb	62.3 ft hyd.	X	X	–	X	1,320 lb	–

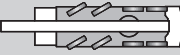
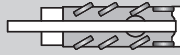
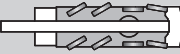
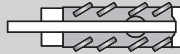
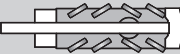
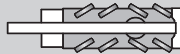







Further configurations on request







	1 Highway > 28 mph		4* Off-wall
	2 City < 28 mph		5* Crab steer mode
	3* Minimum turning radius < 3 mph		6* All wheel steering



* must be activated

		
94,800 lb	134,500 lb	max. 52.8 mph ¹⁾
22.4"	25.2"	

¹⁾ Depending on tire type, size and country specific legislation

				
1	361 ft/min	14,500 lbf	0.72"	870 ft
2	361 ft/min	14,500 lbf	0.72"	870 ft
	1,9 min ⁻¹			
	approx 490 s (39.4 ft - 164.4 ft)			
	approx 590 s (39.4 ft - 194.9 ft)			
	ca. 60 s (0° - 82°)			

					
1	15,000 lb	8-0-18	5	375 lb	3.3 ft
2	29,500 lb	20-1-18	5	662 lb	5.9 ft
3	44,100 lb	20-1-18	5	662 lb	5.9 ft
4	58,600 lb	50-3-18	5	1,320 lb	5.9 ft
5	73,000 lb	50-3-18	5	1,320 lb	5.9 ft
6	87,100 lb	50-3-18	5	1,320 lb	5.9 ft
7	101,200 lb	50-3-18	5	1,320 lb	5.9 ft
8	114,900 lb	80-5-18	5	1,430 lb	6.6 ft
9	128,800 lb	80-5-18	5	1,430 lb	6.6 ft
10	142,200 lb	80-5-18	5	1,430 lb	6.6 ft
11	155,700 lb	80-5-18	5 + 2	1,430 lb	6.6 ft
12	169,100 lb	100-7-18	5 + 2	1,650 lb	6.6 ft
13	176,400 lb	100-7-18	5 + 2	1,650 lb	6.6 ft

	385 / 95 R25 14.00 R25	445 / 95 R25 16.00 R25	525 / 80 R25 20.50 R25
	46 %	42 %	42 %
	> 70 %	> 60 %	> 60 %

HAV / HAV-VA

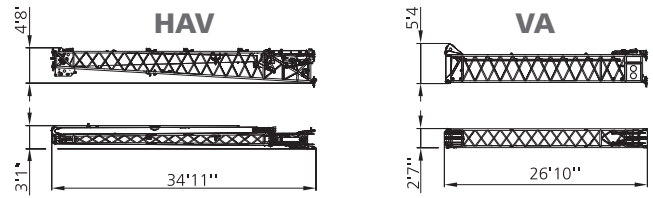

HAV-VA 27-19

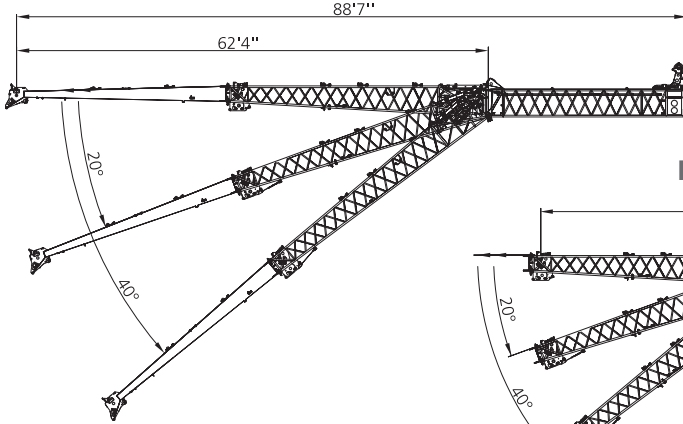

HAV 10

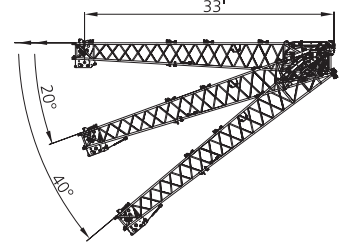

HAV-VA 18

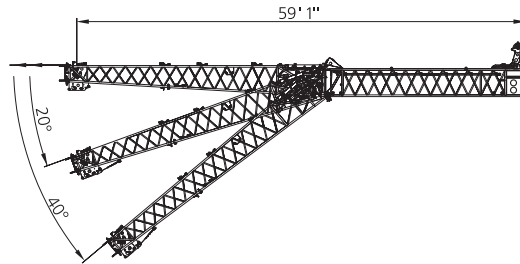

HAV-VA 27-27

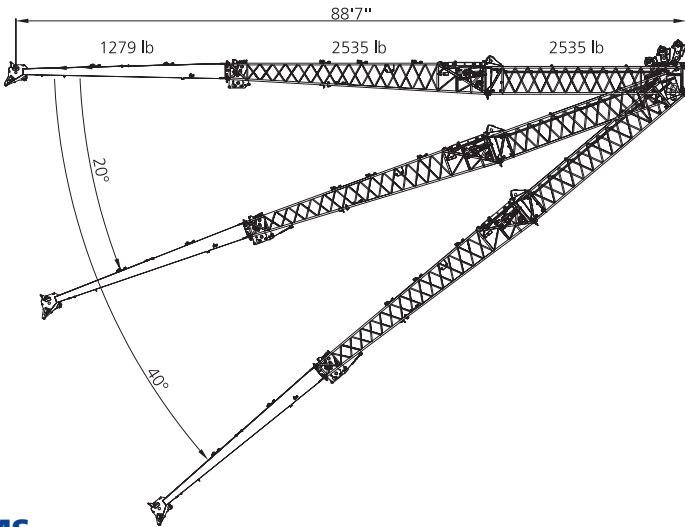

HAV 19

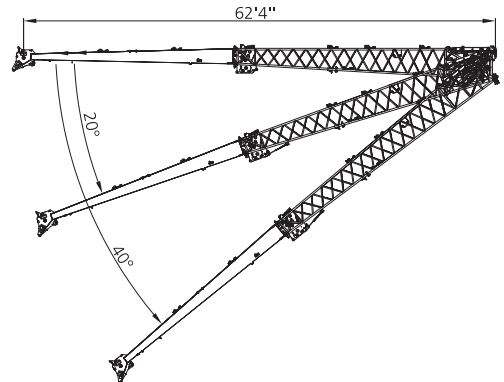

MS

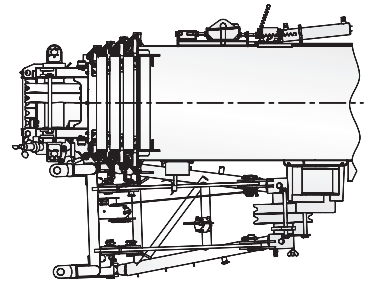
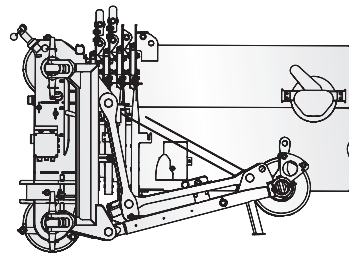
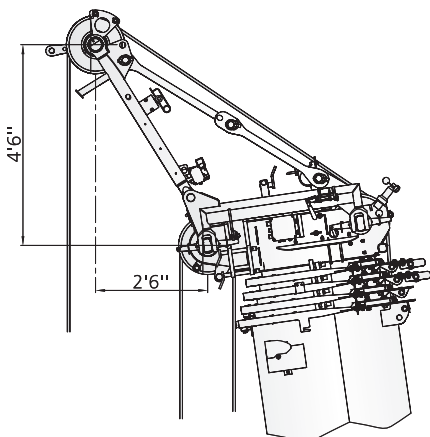

Weight: 750 lb

Counterweight

AC 100-4 / AC 100-4L

Parts

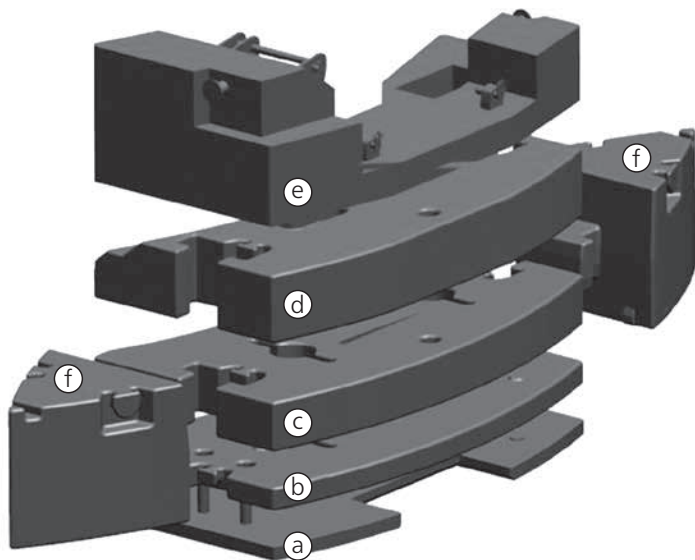

STANDARD

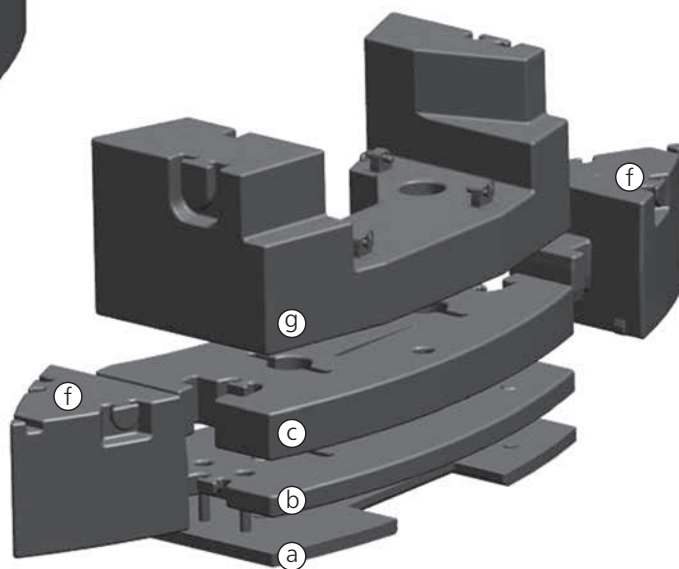

SPECIAL

Configurations

		Ⓐ 4,000 lb	Ⓑ 5,500 lb	Ⓒ 10,600 lb	Ⓓ 13,000 lb	Ⓔ 9,500 lb	Ⓕ 5,700 lb	Ⓖ 5,700 lb	Ⓗ 22,500 lb
STANDARD	0 lb								
	4,000 lb	X							
	9,500 lb					X			
	9,500 lb	X	X						
	13,400 lb	X				X			
	19,000 lb	X	X			X			
	20,000 lb	X	X	X					
	29,500 lb	X	X	X		X			
	33,000 lb	X	X	X	X				
	42,500 lb	X	X	X	X	X			
	44,500 lb	X	X	X	X		X	X	
54,000 lb	X	X	X	X	X	X	X		
SPECIAL	22,500 lb								X
	26,500 lb	X							X
	32,000 lb	X	X						X
	42,500 lb	X	X	X					X
	54,000 lb	X	X	X			X	X	X

Counterweight

AC 100-4 / AC 100-4L

Parts

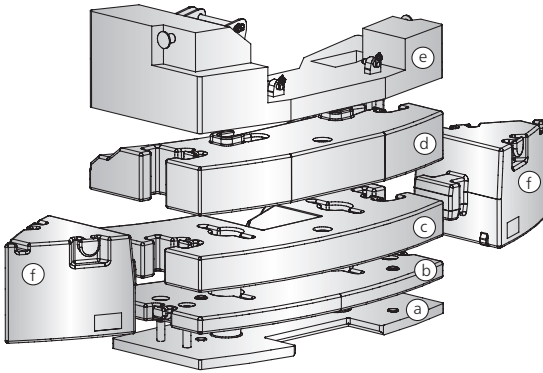

STANDARD

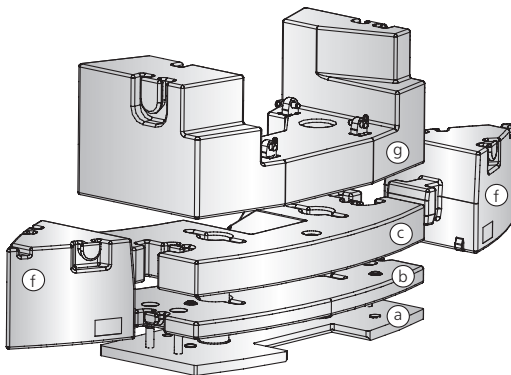
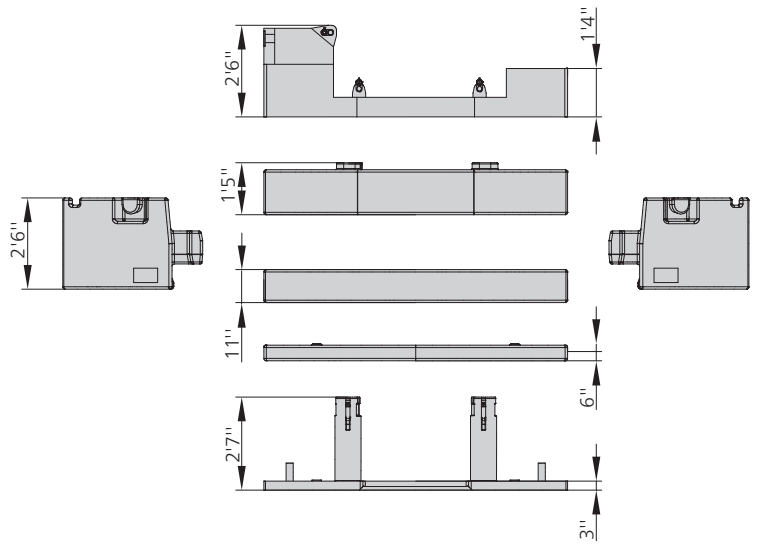

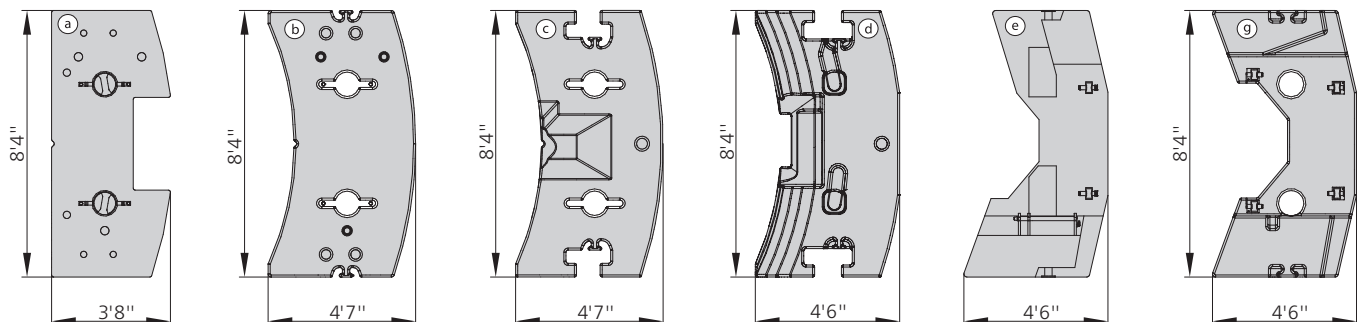
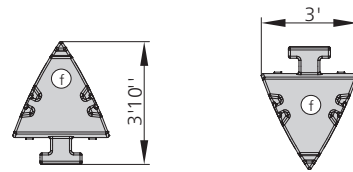
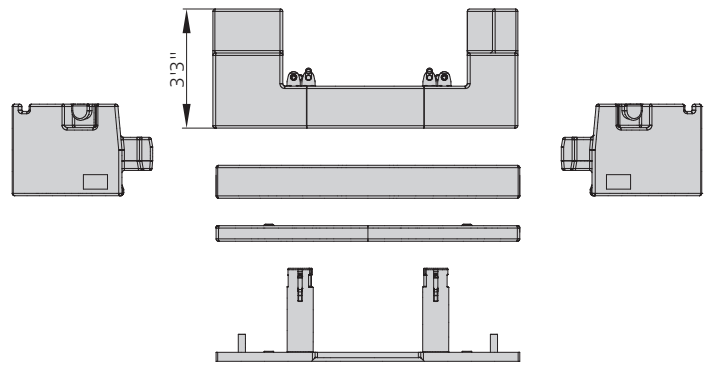

SPECIAL

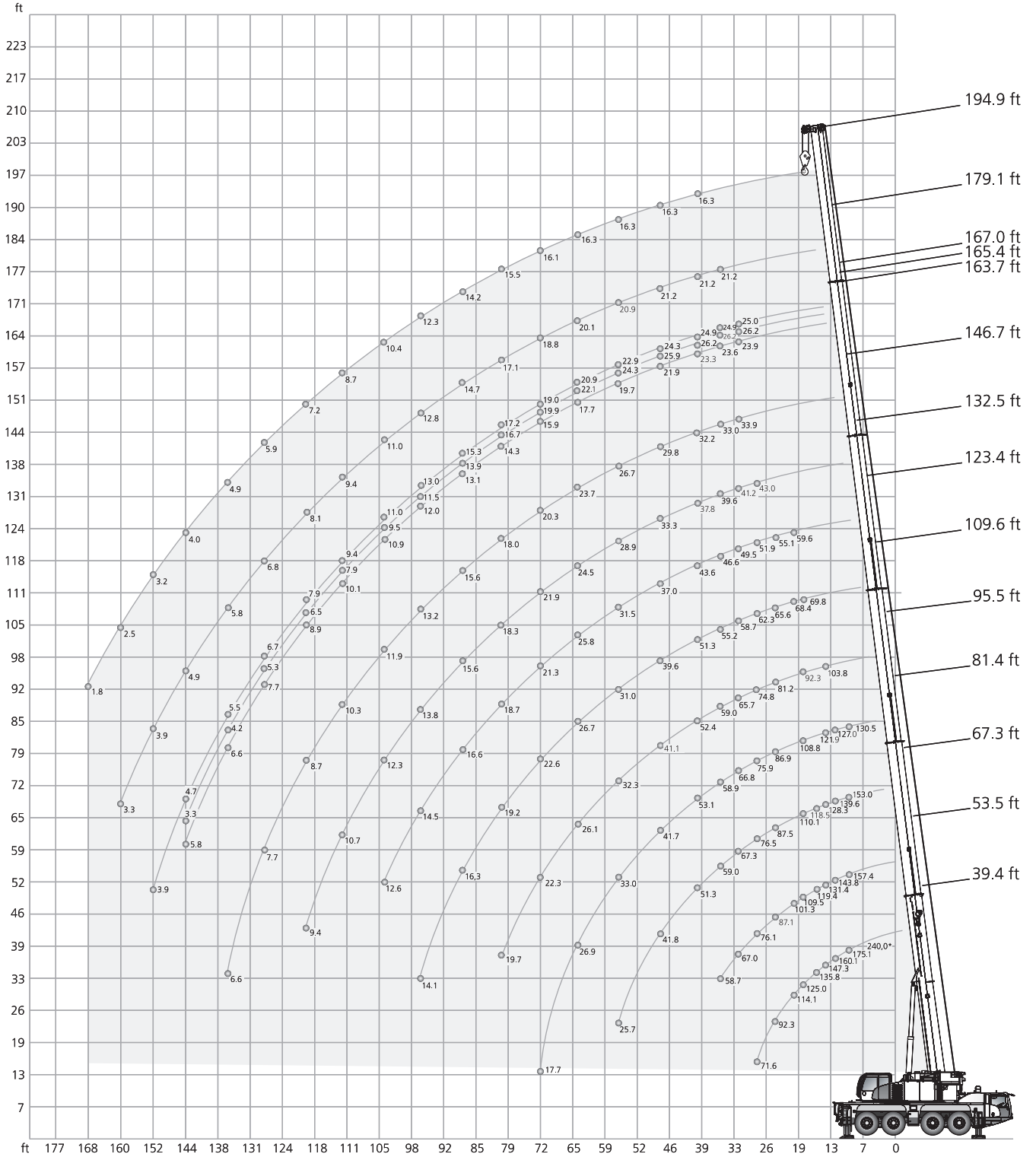
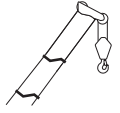



* Capacity class

54,000 lb		26.6 ft x 23.6 ft														360°		ASME B30.5	
																			
(0°)		(ft)																	
39.4		39.4	53.5	67.3	81.4	95.5	109.6	123.4	132.5	146.7	163.7	165.4	167.0	179.1	194.9				
ft		1,000 lb														ft			
8	240.0*	-	-	-	-	-	-	-	-	-	-	-	-	-	-	-	8		
10	175.1	161.2	157.4	153.0	130.5	-	-	-	-	-	-	-	-	-	-	-	10		
12	160.1	145.0	143.8	139.6	127.0	-	-	-	-	-	-	-	-	-	-	-	12		
14	147.3	130.8	131.4	128.3	121.9	103.8	-	-	-	-	-	-	-	-	-	-	14		
16	135.8	118.5	119.4	118.5	116.1	97.8	-	-	-	-	-	-	-	-	-	-	16		
18	125.0	108.6	109.5	110.1	108.8	92.3	69.8	-	-	-	-	-	-	-	-	-	18		
20	114.1	99.4	101.3	101.6	101.1	87.2	68.4	59.6	-	-	-	-	-	-	-	-	20		
24	92.3	85.3	87.1	87.5	86.9	81.2	65.6	55.1	-	-	-	-	-	-	-	-	24		
28	71.6	67.1	76.1	76.5	75.9	74.8	62.3	51.9	43.0	-	-	-	-	-	-	-	28		
32	-	-	67.0	67.3	66.8	65.7	58.7	49.5	41.2	33.9	23.9	26.2	25.0	-	-	-	32		
36	-	-	58.7	59.0	58.9	59.0	55.2	46.6	39.6	33.0	23.6	26.2	24.9	21.2	-	-	36		
40	-	-	-	51.3	53.1	52.4	51.3	43.6	37.8	32.2	23.3	26.2	24.9	21.2	16.3	-	40		
48	-	-	-	41.8	41.7	41.1	39.6	37.0	33.3	29.8	21.9	25.9	24.3	21.2	16.3	-	48		
56	-	-	-	25.7	33.0	32.3	31.0	31.5	28.9	26.7	19.7	24.3	22.9	20.9	16.3	-	56		
64	-	-	-	-	26.9	26.1	26.7	25.8	24.5	23.7	17.7	22.1	20.9	20.1	16.3	-	64		
72	-	-	-	-	17.7	22.3	22.6	21.3	21.9	20.3	15.9	19.9	19.0	18.8	16.1	-	72		
80	-	-	-	-	-	19.7	19.2	18.7	18.3	18.0	14.3	16.7	17.2	17.1	15.5	-	80		
88	-	-	-	-	-	9.3	16.3	16.6	15.6	15.6	13.1	13.9	15.3	14.7	14.2	-	88		
96	-	-	-	-	-	-	14.1	14.5	13.8	13.2	12.0	11.5	13.0	12.8	12.3	-	96		
104	-	-	-	-	-	-	8.9	12.6	12.3	11.9	10.9	9.5	11.0	11.0	10.4	-	104		
112	-	-	-	-	-	-	-	-	10.7	10.3	10.1	7.9	9.4	9.4	8.7	-	112		
120	-	-	-	-	-	-	-	-	9.4	8.7	8.9	6.5	7.9	8.1	7.2	-	120		
128	-	-	-	-	-	-	-	-	-	7.7	7.7	5.3	6.7	6.8	5.9	-	128		
136	-	-	-	-	-	-	-	-	-	6.6	6.6	4.2	5.5	5.8	4.9	-	136		
144	-	-	-	-	-	-	-	-	-	-	5.8	3.3	4.7	4.9	4.0	-	144		
152	-	-	-	-	-	-	-	-	-	-	-	-	3.9	3.9	3.2	-	152		
160	-	-	-	-	-	-	-	-	-	-	-	-	-	3.3	2.5	-	160		
168	-	-	-	-	-	-	-	-	-	-	-	-	-	-	1.8	-	168		

* Capacity class

		42,500 lb						26.6 ft x 23.6 ft						360° / Max.*				ASME B30.5	
ft	ft	360°	Max.	360°	Max.	360°	Max.	360°	Max.	360°	Max.	360°	Max.	360°	Max.	360°	Max.		
		39.4ft	39.4ft	53.5ft	53.5ft	67.3ft	67.3ft	81.4ft	81.4ft	95.5ft	95.5ft	109.6ft	109.6ft	123.4ft	123.4ft				
		1,000 lb																	
10		160.5	161.2	157.4	157.4	153.0	153.0	130.5	130.5	-	-	-	-	-	-	-	-		
12		143.9	145.0	143.6	143.9	139.6	139.6	127.0	127.0	-	-	-	-	-	-	-	-		
14		129.4	130.8	130.1	131.4	128.3	128.3	121.9	121.9	103.8	103.8	-	-	-	-	-	-		
16		117.2	118.5	118.0	119.4	118.4	118.5	116.1	116.1	97.8	97.8	-	-	-	-	-	-		
18		107.4	108.6	109.0	109.5	109.6	110.1	108.2	108.7	92.3	92.3	69.8	69.8	-	-	-	-		
20		98.3	99.4	100.2	101.3	100.5	101.6	100.0	101.1	87.2	87.2	68.4	68.4	59.6	59.6	-	-		
24		84.2	85.3	86.2	87.1	86.5	87.5	86.0	86.9	81.1	81.2	65.6	65.6	55.1	55.1	-	-		
28		66.7	67.1	74.4	74.9	74.7	75.2	74.2	74.7	73.2	73.5	62.3	62.3	51.9	51.9	-	-		
32		-	-	63.2	64.0	63.7	64.2	64.3	64.5	63.6	64.0	58.7	58.7	49.5	49.5	-	-		
36		-	-	54.2	55.6	54.6	55.8	56.5	57.5	55.7	56.8	52.6	53.6	46.6	46.6	-	-		
40		-	-	-	-	48.4	49.5	48.4	50.1	47.5	49.2	46.0	47.9	43.3	43.5	-	-		
48		-	-	-	-	36.5	38.1	36.5	38.0	35.6	37.3	34.3	36.1	35.0	35.6	-	-		
56		-	-	-	-	23.0	24.5	28.7	30.0	27.8	29.4	28.8	29.4	27.7	29.1	-	-		
64		-	-	-	-	-	-	23.1	24.4	24.0	24.6	23.5	24.8	22.6	23.5	-	-		
72		-	-	-	-	-	-	17.0	17.0	20.1	21.2	19.3	20.6	19.7	20.3	-	-		
80		-	-	-	-	-	-	-	-	17.0	18.1	16.5	17.4	16.6	17.7	-	-		
88		-	-	-	-	-	-	-	-	9.3	9.2	14.9	15.2	14.0	15.1	-	-		
96		-	-	-	-	-	-	-	-	-	-	12.9	13.7	12.5	13.1	-	-		
104		-	-	-	-	-	-	-	-	-	-	8.9	8.9	10.8	11.4	-	-		

ft	ft	360°	Max.	360°	Max.	360°	Max.	360°	Max.	360°	Max.	360°	Max.	360°	Max.
		132.5ft	132.5ft	146.7ft	146.7ft	163.7ft	163.7ft	165.4ft	165.4ft	167.0ft	167.0ft	179.1ft	179.1ft	194.9ft	194.9ft
		1,000 lb													
28		43.0	43.0	-	-	-	-	-	-	-	-	-	-	-	-
32		41.2	41.2	33.9	33.9	23.9	26.2	26.2	26.2	25.0	25.0	-	-	-	-
36		39.6	39.6	33.0	33.0	23.6	26.2	26.2	26.2	24.9	24.9	21.2	21.2	-	-
40		37.8	37.8	32.2	32.2	23.3	26.2	26.2	26.2	24.9	24.9	21.2	21.2	16.3	16.3
48		32.4	33.0	29.8	29.8	21.9	25.9	25.9	25.9	24.3	24.3	21.2	21.2	16.3	16.3
56		26.7	27.4	25.5	26.5	19.7	24.3	24.3	24.3	22.9	22.9	20.9	20.9	16.3	16.3
64		22.7	23.6	21.9	22.6	17.7	22.1	20.9	22.1	20.9	20.9	20.1	20.1	16.3	16.3
72		18.6	19.9	18.6	19.7	15.9	19.0	17.1	18.4	18.4	19.0	17.7	18.8	16.1	16.1
80		16.4	16.8	15.9	16.8	14.3	16.6	13.9	15.2	15.2	16.6	15.3	15.9	14.2	15.4
88		14.0	14.9	13.5	14.4	13.1	14.0	11.2	12.6	12.6	14.0	12.9	13.8	11.8	13.3
96		12.0	13.1	11.4	12.6	11.6	12.0	9.0	10.5	10.5	11.8	10.7	11.9	9.8	11.2
104		10.2	11.3	9.8	10.8	9.9	10.9	7.3	8.6	8.8	9.9	8.8	10.1	8.1	9.5
112		8.7	9.8	9.0	9.2	8.3	9.4	5.9	7.2	7.2	8.5	7.4	8.5	6.5	7.9
120		7.5	8.6	7.7	8.3	7.0	8.1	4.6	5.9	5.9	7.2	6.1	7.2	5.3	6.6
128		-	-	6.6	7.6	5.9	7.0	3.5	4.8	4.8	6.2	5.1	6.2	4.2	5.5
136		-	-	4.8	5.9	5.0	6.1	2.6	3.9	3.9	5.1	4.0	5.3	3.3	4.4
144		-	-	-	-	4.2	5.1	1.8	3.1	3.1	4.2	3.1	4.4	2.5	3.6
152		-	-	-	-	-	-	-	-	2.4	-	2.5	3.6	-	3.0
160		-	-	-	-	-	-	-	-	-	-	1.8	2.9	-	2.3

* Max. values are valid only for specific superstructure positions

		19,000 lb						26.6 ft x 23.6 ft						360° / Max.*				ASME B30.5	
		360°		Max.		360°		Max.		360°		Max.		360°		Max.			
		39.4ft		39.4ft		53.5ft		53.5ft		67.3ft		67.3ft		81.4ft		81.4ft			
		360°		Max.		360°		Max.		360°		Max.		360°		Max.			
		95.5ft		95.5ft		109.6ft		109.6ft		123.4ft		123.4ft							
		1,000 lb		1,000 lb		1,000 lb		1,000 lb		1,000 lb		1,000 lb		1,000 lb		1,000 lb			
ft																			ft
10		158.0	161.2	157.2	157.4	153.0	153.0	130.5	130.5	-	-	-	-	-	-	-	-	-	10
12		140.7	145.0	141.4	143.9	139.5	139.6	127.0	127.0	-	-	-	-	-	-	-	-	-	12
14		126.4	130.8	127.3	131.4	126.9	128.3	121.9	121.9	103.8	103.8	-	-	-	-	-	-	-	14
16		114.5	118.5	115.9	119.4	116.3	118.5	115.3	116.1	97.8	97.8	-	-	-	-	-	-	-	16
18		104.8	107.7	106.7	108.9	106.9	109.5	105.3	108.0	91.8	92.3	69.8	69.8	-	-	-	-	-	18
20		95.4	97.2	97.4	99.6	97.7	99.8	94.6	99.2	85.3	87.2	68.4	68.4	59.6	59.6	-	-	-	20
24		75.1	78.4	77.9	80.5	78.6	80.8	73.9	80.3	69.2	78.6	63.8	65.6	55.1	55.1	-	-	-	24
28		58.0	63.2	61.2	67.0	62.2	67.4	62.8	67.6	58.9	66.3	53.8	62.3	49.4	51.9	-	-	-	28
32		-	-	48.9	57.0	50.8	58.4	50.7	58.8	49.2	58.3	46.4	56.7	43.0	49.5	-	-	-	32
36		-	-	40.8	49.8	42.3	51.6	42.2	51.5	41.3	51.0	40.5	49.9	38.4	46.3	-	-	-	36
40		-	-	-	-	34.9	45.1	34.9	45.1	34.9	44.4	35.4	43.4	33.7	42.6	-	-	-	40
48		-	-	-	-	25.8	36.1	27.1	36.0	27.1	35.5	26.3	34.3	26.7	35.2	-	-	-	48
56		-	-	-	-	17.7	23.5	21.4	29.1	21.0	28.5	21.4	29.1	21.0	28.1	-	-	-	56
64		-	-	-	-	-	-	17.1	23.8	17.3	24.5	17.1	24.1	17.1	22.7	-	-	-	64
72		-	-	-	-	-	-	14.0	17.0	14.2	20.6	14.0	19.9	13.7	20.3	-	-	-	72
80		-	-	-	-	-	-	-	-	11.8	17.6	11.4	16.7	11.3	17.2	-	-	-	80
88		-	-	-	-	-	-	-	-	9.3	9.2	9.6	15.2	9.2	14.5	-	-	-	88
96		-	-	-	-	-	-	-	-	-	-	8.0	13.4	7.5	12.6	-	-	-	96
104		-	-	-	-	-	-	-	-	-	-	6.6	8.9	6.1	11.4	-	-	-	104

		360°		Max.		360°		Max.		360°		Max.		360°		Max.			
		132.5ft		132.5ft		146.7ft		146.7ft		163.7ft		163.7ft		165.4ft		165.4ft			
		360°		Max.		360°		Max.		360°		Max.		360°		Max.			
		179.1ft		179.1ft		194.9ft		194.9ft		179.1ft		179.1ft		194.9ft		194.9ft			
		1,000 lb		1,000 lb		1,000 lb		1,000 lb		1,000 lb		1,000 lb		1,000 lb		1,000 lb			
ft																			ft
28		43.0	43.0	-	-	-	-	-	-	-	-	-	-	-	-	-	-	-	28
32		39.2	41.2	33.9	33.9	23.9	26.2	26.2	26.2	25.0	25.0	-	-	-	-	-	-	-	32
36		34.7	39.6	31.3	33.0	23.6	26.2	26.2	26.2	24.9	24.9	21.2	21.2	-	-	-	-	-	36
40		32.5	37.8	29.9	32.2	23.3	26.2	25.9	26.2	24.9	24.9	21.2	21.2	16.3	16.3	-	-	-	40
48		25.8	32.4	25.3	29.8	21.9	25.9	21.5	25.9	23.3	24.3	20.5	21.2	16.3	16.3	-	-	-	48
56		20.7	27.0	20.1	25.5	19.4	24.3	16.6	24.3	18.4	22.9	18.0	20.9	15.4	16.3	-	-	-	56
64		16.4	23.2	16.4	21.9	15.8	21.1	12.8	21.1	14.4	20.9	14.2	20.1	12.4	16.3	-	-	-	64
72		13.7	19.0	13.5	19.0	12.6	19.0	9.8	17.3	11.3	19.0	11.1	17.9	9.5	16.1	-	-	-	72
80		11.3	16.5	10.9	16.1	10.2	15.7	7.4	14.4	8.9	15.7	8.7	15.4	7.2	14.8	-	-	-	80
88		9.3	14.6	8.8	14.2	8.2	13.3	5.5	12.0	7.0	13.3	6.7	13.4	5.4	12.5	-	-	-	88
96		7.7	12.5	7.1	12.0	6.4	12.0	3.8	9.8	5.3	11.2	5.3	11.2	4.1	10.4	-	-	-	96
104		6.3	10.8	5.7	10.2	5.0	10.4	2.6	8.1	3.9	9.5	4.1	9.5	2.8	8.6	-	-	-	104
112		5.0	9.4	4.6	9.0	3.9	9.0	-	6.8	2.8	8.1	3.0	8.1	1.9	7.0	-	-	-	112
120		3.3	8.1	3.6	8.3	3.0	8.0	-	5.5	1.9	6.8	2.0	7.2	-	5.7	-	-	-	120
128		-	-	2.8	7.4	2.1	6.8	-	4.6	-	5.7	-	5.9	-	4.7	-	-	-	128
136		-	-	-	5.8	-	5.8	-	3.9	-	5.0	-	4.9	-	3.9	-	-	-	136
144		-	-	-	-	-	5.1	-	3.1	-	4.2	-	4.0	-	3.1	-	-	-	144
152		-	-	-	-	-	-	-	-	-	-	-	3.6	-	2.6	-	-	-	152
160		-	-	-	-	-	-	-	-	-	-	-	2.9	-	2.3	-	-	-	160

* Max. values are valid only for specific superstructure positions

		13,400 lb						26.6 ft x 23.6 ft						360° / Max.*				ASME B30.5	
ft	ft	360°	Max.	360°	Max.	360°	Max.	360°	Max.	360°	Max.	360°	Max.	360°	Max.	360°	Max.		
		39.4ft	39.4ft	53.5ft	53.5ft	67.3ft	67.3ft	81.4ft	81.4ft	95.5ft	95.5ft	109.6ft	109.6ft	123.4ft	123.4ft				
		1,000 lb																	
10		157.1	161.2	157.2	157.4	153.0	153.0	130.5	130.5	-	-	-	-	-	-	-	-		
12		139.8	145.0	140.7	143.9	139.2	139.6	127.0	127.0	-	-	-	-	-	-	-	-		
14		125.7	130.8	126.5	131.4	126.2	128.3	121.9	121.9	103.8	103.8	-	-	-	-	-	-		
16		113.8	118.5	115.4	119.4	115.9	118.5	114.8	116.1	97.8	97.8	-	-	-	-	-	-		
18		102.9	106.4	105.2	107.6	105.6	108.2	101.3	106.7	88.3	92.3	69.8	69.8	-	-	-	-		
20		92.1	94.6	94.9	97.0	95.1	97.2	87.2	96.6	78.2	87.1	68.1	68.4	59.6	59.6	-	-		
24		71.2	76.3	74.2	78.4	73.0	78.7	70.8	78.2	66.1	76.9	60.1	65.6	54.1	55.1	-	-		
28		52.7	62.2	56.0	65.3	59.1	65.6	57.8	66.6	53.9	65.4	50.6	62.3	46.2	51.9	-	-		
32		-	-	45.2	55.6	46.5	57.2	46.5	57.2	45.1	56.7	43.2	55.5	40.5	49.5	-	-		
36		-	-	37.3	48.5	38.6	50.2	38.5	50.1	37.7	49.5	37.9	48.4	35.5	45.2	-	-		
40		-	-	-	-	31.9	43.8	31.7	43.8	33.2	43.1	32.3	42.0	32.0	41.0	-	-		
48		-	-	-	-	23.6	34.7	24.9	34.6	24.6	33.7	25.1	33.1	24.6	33.0	-	-		
56		-	-	-	-	17.7	21.6	19.5	27.1	19.7	27.3	19.5	27.6	19.3	26.3	-	-		
64		-	-	-	-	-	-	15.3	22.2	15.5	23.1	15.3	22.5	15.1	22.5	-	-		
72		-	-	-	-	-	-	12.4	17.0	12.6	19.3	12.4	18.6	12.2	18.8	-	-		
80		-	-	-	-	-	-	-	-	10.2	16.3	10.1	16.4	9.6	16.1	-	-		
88		-	-	-	-	-	-	-	-	8.5	9.2	8.3	14.3	7.8	13.7	-	-		
96		-	-	-	-	-	-	-	-	-	-	6.7	12.4	6.2	12.2	-	-		
104		-	-	-	-	-	-	-	-	-	-	5.4	8.9	5.0	10.6	-	-		

ft	ft	360°	Max.	360°	Max.	360°	Max.	360°	Max.	360°	Max.	360°	Max.	360°	Max.
		132.5ft	132.5ft	146.7ft	146.7ft	163.7ft	163.7ft	165.4ft	165.4ft	167.0ft	167.0ft	179.1ft	179.1ft	194.9ft	194.9ft
		1,000 lb													
28		42.0	43.0	-	-	-	-	-	-	-	-	-	-	-	-
32		36.6	41.2	33.9	33.9	23.9	26.2	26.2	25.0	25.0	-	-	-	-	-
36		33.0	39.6	29.8	33.0	23.6	26.2	25.9	26.2	24.9	24.9	21.2	21.2	-	-
40		29.8	37.5	28.3	32.2	23.3	26.2	25.0	26.2	24.6	24.9	21.1	21.2	16.3	16.3
48		24.2	31.0	22.6	29.3	21.5	25.9	18.8	25.9	20.7	24.3	19.2	21.2	16.1	16.3
56		18.6	26.1	18.4	24.6	17.5	23.5	14.3	23.5	16.0	22.9	15.5	20.9	13.8	16.3
64		15.1	21.8	14.9	21.2	13.7	20.6	10.6	19.6	12.2	20.6	11.9	19.7	10.1	16.3
72		12.2	18.3	11.7	17.9	10.6	17.3	7.8	16.0	9.3	17.3	9.1	16.8	7.5	16.1
80		9.8	15.9	9.4	15.4	8.5	14.6	5.7	13.3	7.2	14.6	7.0	14.6	5.5	13.0
88		8.0	13.5	7.4	13.0	6.7	13.1	4.1	10.9	5.5	12.3	5.3	12.0	4.0	10.4
96		6.4	11.6	5.8	11.2	5.3	11.5	2.6	8.9	4.2	10.2	3.9	9.8	2.6	8.4
104		5.0	9.9	4.5	9.8	3.9	9.6	-	7.3	2.8	8.6	2.8	8.3	-	6.8
112		4.1	8.5	3.5	9.0	2.8	8.3	-	5.9	-	7.2	-	7.0	-	5.5
120		2.5	7.5	2.7	7.7	2.0	7.1	-	4.8	-	6.1	-	5.7	-	4.4
128		-	-	-	6.6	-	6.2	-	3.7	-	5.1	-	4.7	-	3.4
136		-	-	-	5.0	-	5.1	-	2.7	-	4.0	-	3.9	-	2.6
144		-	-	-	-	-	4.2	-	1.8	-	3.1	-	3.3	-	2.0
152		-	-	-	-	-	-	-	-	-	-	-	2.5	-	-
160		-	-	-	-	-	-	-	-	-	-	-	1.8	-	-

* Max. values are valid only for specific superstructure positions

9,500 lb		26.6 ft x 23.6 ft						360° / Max.*						ASME B30.5	
ft	360° 39.4ft	Max. 39.4ft	360° 53.5ft	Max. 53.5ft	360° 67.3ft	Max. 67.3ft	360° 81.4ft	Max. 81.4ft	360° 95.5ft	Max. 95.5ft	360° 109.6ft	Max. 109.6ft	360° 123.4ft	Max. 123.4ft	ft
10	156.5	161.2	157.1	157.4	153.0	153.0	130.5	130.5	-	-	-	-	-	-	10
12	139.4	145.0	140.1	143.9	139.1	139.6	127.0	127.0	-	-	-	-	-	-	12
14	125.3	130.8	126.0	131.4	125.7	128.3	121.9	121.9	103.8	103.8	-	-	-	-	14
16	113.4	118.5	115.1	119.4	115.5	118.5	110.6	116.1	96.8	97.8	-	-	-	-	16
18	101.4	105.5	103.7	106.6	102.5	107.3	95.7	105.9	85.2	92.3	69.8	69.8	-	-	18
20	89.2	92.6	92.2	95.0	89.3	95.5	81.6	94.8	73.8	86.9	67.7	68.4	59.5	59.6	20
24	66.3	74.8	70.1	76.8	68.8	77.2	67.0	76.6	61.9	75.4	57.0	65.6	52.0	55.1	24
28	48.8	61.6	53.2	64.0	55.3	64.2	53.9	65.7	50.4	64.6	48.0	61.7	44.5	51.9	28
32	-	-	42.0	54.3	43.3	56.2	43.3	56.0	42.5	55.5	41.3	54.4	38.6	49.5	32
36	-	-	34.5	47.3	35.9	49.2	35.9	49.1	36.1	48.5	35.5	46.9	33.9	44.1	36
40	-	-	-	-	29.5	42.9	31.1	42.8	30.8	42.1	30.2	40.1	30.0	39.4	40
48	-	-	-	-	22.4	32.9	23.1	32.9	23.1	32.0	23.3	32.7	23.1	31.3	48
56	-	-	-	-	17.0	20.4	17.8	25.7	18.1	26.8	17.8	26.3	17.6	25.2	56
64	-	-	-	-	-	-	13.9	21.6	14.2	22.0	13.9	21.4	13.7	21.7	64
72	-	-	-	-	-	-	11.1	17.0	11.3	18.2	11.3	18.3	10.6	17.9	72
80	-	-	-	-	-	-	-	-	9.2	15.5	9.0	15.9	8.5	15.2	80
88	-	-	-	-	-	-	-	-	7.6	9.2	7.2	13.5	6.7	13.4	88
96	-	-	-	-	-	-	-	-	-	-	5.8	11.7	5.3	11.5	96
104	-	-	-	-	-	-	-	-	-	-	4.5	8.9	4.1	10.1	104

ft	360° 132.5ft	Max. 132.5ft	360° 146.7ft	Max. 146.7ft	360° 163.7ft	Max. 163.7ft	360° 165.4ft	Max. 165.4ft	360° 167.0ft	Max. 167.0ft	360° 179.1ft	Max. 179.1ft	360° 194.9ft	Max. 194.9ft	ft
28	39.6	43.0	-	-	-	-	-	-	-	-	-	-	-	-	28
32	35.9	41.2	31.7	33.9	23.9	26.2	26.2	26.2	25.0	25.0	-	-	-	-	32
36	31.6	39.6	28.4	33.0	23.6	26.2	24.7	26.2	24.9	24.9	21.2	21.2	-	-	36
40	28.8	37.3	27.0	32.2	23.2	26.2	22.6	26.2	24.4	24.9	20.9	21.2	16.3	16.3	40
48	22.0	29.8	21.1	28.5	20.3	25.9	16.7	25.9	18.6	24.3	18.2	21.2	15.4	16.3	48
56	17.4	25.2	17.1	24.0	15.5	22.9	12.3	22.9	14.1	22.9	13.7	20.9	11.8	16.3	56
64	13.9	20.7	13.3	20.4	11.9	19.9	9.0	18.3	10.6	19.9	10.1	18.4	8.5	16.3	64
72	10.9	17.9	10.4	17.3	9.3	16.4	6.4	14.6	8.0	16.4	7.5	15.9	6.0	14.2	72
80	8.7	15.2	8.1	14.6	7.2	14.3	4.4	11.6	5.9	13.2	5.7	12.8	4.2	11.1	80
88	7.0	12.8	6.3	12.4	5.6	12.3	2.9	9.4	4.4	11.0	4.2	10.5	2.9	8.8	88
96	5.5	11.1	4.9	10.8	4.2	10.3	-	7.5	3.0	8.9	2.9	8.5	-	7.1	96
104	4.3	9.5	3.7	9.8	3.0	8.6	-	5.9	1.9	7.4	1.9	7.0	-	5.5	104
112	3.3	8.1	2.6	8.1	2.0	7.2	-	4.8	-	6.1	-	5.7	-	4.3	112
120	-	6.6	1.9	6.8	-	6.1	-	3.7	-	5.0	-	4.7	-	3.3	120
128	-	-	-	5.7	-	5.1	-	2.6	-	4.1	-	3.9	-	2.5	128
136	-	-	-	4.0	-	4.1	-	1.7	-	3.1	-	3.0	-	1.7	136
144	-	-	-	-	-	3.3	-	-	-	2.2	-	2.4	-	-	144

* Max. values are valid only for specific superstructure positions

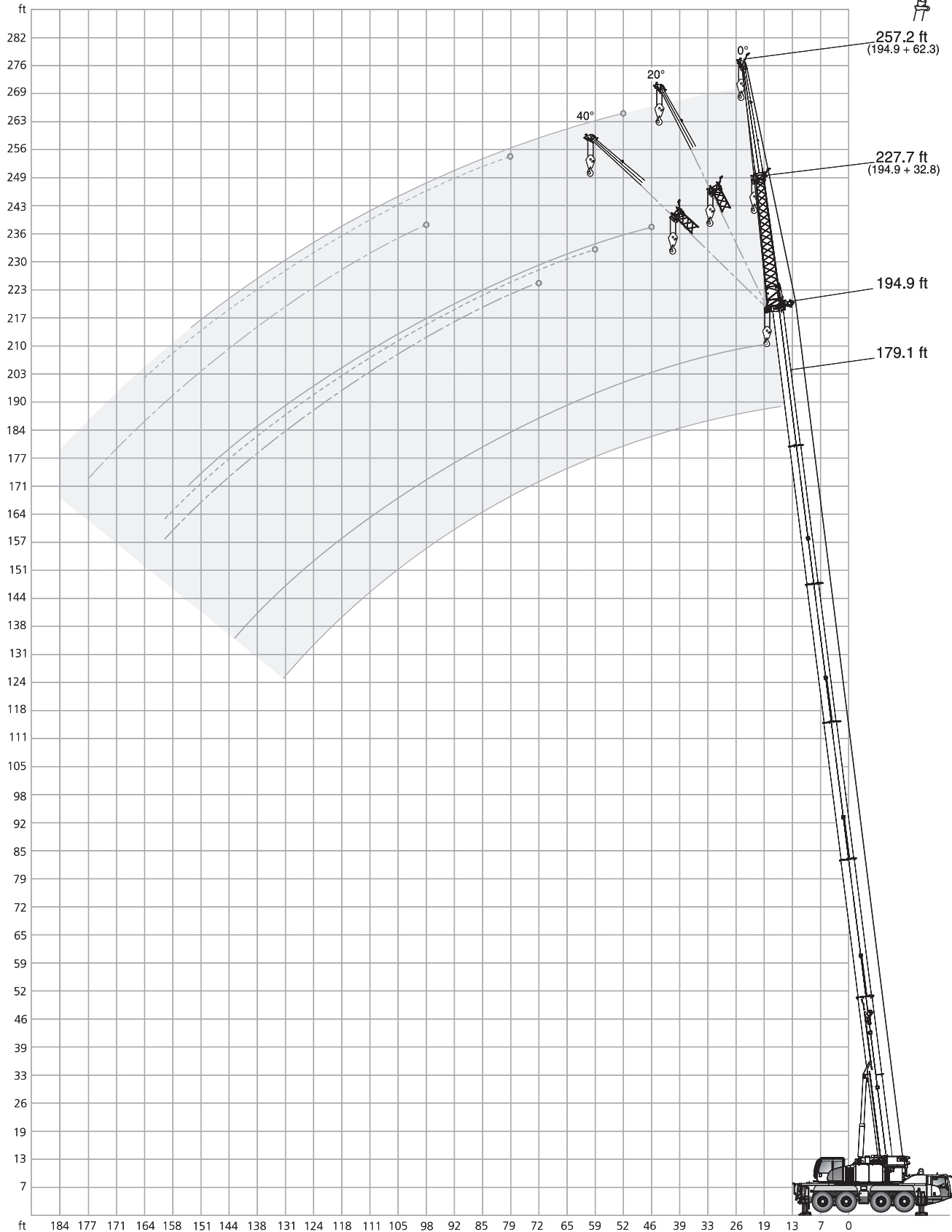
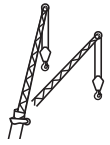

54,000 lb		26.6 ft x 23.6 ft		360°			ASME B30.5			
194.9 ft		32.8 ft			62.3 ft			179.1 ft		
ft	0°	20°	40°	0°	20°	40°*	ft	0°	20°	40°
	1,000 lb							1,000 lb		
48	8.4	-	-	-	-	-	40	11.0	-	-
56	8.4	-	-	4.9	-	-	48	11.0	-	6.4
64	8.4	8.4	-	4.9	-	-	56	11.0	-	6.4
72	8.4	8.4	-	4.9	-	-	64	11.0	11.0	6.4
80	8.4	8.4	8.4	4.9	4.9	-	72	11.0	11.0	11.0
88	8.4	8.4	8.4	4.9	4.9	-	80	11.0	11.0	11.0
96	8.4	8.4	8.2	4.9	4.9	-	88	11.0	11.0	11.0
104	8.4	8.0	7.8	4.9	4.9	5.1	96	10.7	11.0	10.7
112	7.6	7.7	7.3	4.9	4.9	5.1	104	9.6	10.5	10.4
120	6.4	7.0	6.9	4.9	4.9	4.9	112	8.1	8.9	9.6
128	5.3	5.9	6.3	4.6	4.7	4.5	120	7.1	7.4	8.0
136	4.2	4.9	5.3	3.9	4.5	4.2	128	6.1	6.3	6.5
144	3.1	3.8	4.2	3.1	4.2	4.0	136	5.0	5.5	5.8
152	2.3	3.0	3.2	2.3	3.4	3.7	144	4.0	4.5	4.9
160	-	2.2	2.4	-	2.6	3.4	152	3.2	3.6	3.9
168	-	-	-	-	-	2.7	160	2.5	2.8	3.1
176	-	-	-	-	-	1.9	168	-	-	-
							176	-	-	-

109.6 ft		32.8 ft			62.3 ft		
ft	0°	20°	40°	0°	20°	40°	
	1,000 lb						
20	29.1	-	-	-	-	-	
24	28.7	-	-	14.7	-	-	
28	28.2	-	-	14.6	-	-	
32	27.7	-	-	14.4	-	-	
36	27.1	24.4	-	14.2	-	-	
40	26.6	23.2	19.1	14.1	-	-	
48	25.4	21.1	18.0	13.8	-	-	
56	23.9	19.5	16.8	13.4	12.1	-	
64	21.8	18.1	16.0	13.1	11.6	-	
72	19.9	16.8	15.2	12.8	11.0	8.6	
80	17.7	15.7	14.5	12.3	10.3	8.3	
88	15.0	14.9	13.9	11.6	9.7	8.1	
96	13.2	13.4	13.4	10.8	9.2	7.9	
104	11.7	11.7	12.0	10.2	8.9	7.7	
112	10.0	10.5	-	9.4	8.3	7.7	
120	8.8	8.9	-	8.7	7.9	7.4	
128	8.2	4.5	-	7.8	7.6	7.3	
136	4.1	-	-	6.9	7.1	7.3	
144	-	-	-	5.8	6.4	2.9	
152	-	-	-	5.0	4.5	-	
160	-	-	-	2.3	-	-	

39.4 ft		32.8 ft			62.3 ft		
ft	0°	20°	40°	0°	20°	40°	
	1,000 lb						
10	29.1	-	-	21.1	-	-	
12	29.1	-	-	20.9	-	-	
14	29.1	-	-	20.8	-	-	
16	29.1	29.1	-	20.6	-	-	
18	29.1	29.1	-	20.3	-	-	
20	29.1	28.9	-	20.0	-	-	
24	29.1	26.6	-	19.2	-	-	
28	29.1	24.5	20.1	18.5	-	-	
32	28.9	22.8	19.2	17.6	-	-	
36	26.9	21.5	18.4	16.7	13.5	-	
40	24.6	20.3	17.8	15.7	12.7	-	
48	21.1	18.3	16.9	13.8	11.6	-	
56	18.5	17.1	-	12.2	10.4	9.2	
64	-	-	-	11.0	9.6	8.7	
72	-	-	-	9.9	9.1	8.2	
80	-	-	-	9.2	8.6	-	
88	-	-	-	8.6	-	-	

 * 191.9 ft

42,500 lb		26.6 ft x 23.6 ft		360°			ASME B30.5			
194.9 ft		32.8 ft			62.3 ft			179.1 ft		
ft	0°	20°	40°	0°	20°	40°*	ft	0°	20°	40°
48	8.4	-	-	-	-	-	40	11.0	-	-
56	8.4	-	-	4.9	-	-	48	11.0	-	6.4
64	8.4	8.4	-	4.9	-	-	56	11.0	-	6.4
72	8.4	8.4	-	4.9	-	-	64	11.0	11.0	6.4
80	8.4	8.4	8.4	4.9	4.9	-	72	11.0	11.0	11.0
88	8.4	8.4	8.4	4.9	4.9	-	80	11.0	11.0	11.0
96	8.0	8.4	8.2	4.9	4.9	-	88	10.6	11.0	11.0
104	6.8	7.6	7.8	4.9	4.9	5.1	96	9.1	10.1	10.6
112	5.4	6.3	7.2	4.8	4.9	5.1	104	8.1	8.4	9.2
120	4.2	5.0	5.7	3.7	4.8	4.9	112	6.6	7.2	7.4
128	3.3	4.0	4.6	2.8	4.3	4.5	120	5.4	6.1	6.4
136	2.4	3.0	3.5	1.9	3.3	4.2	128	4.2	4.8	5.4
144	1.6	2.2	2.7	-	2.5	3.8	136	3.3	3.9	4.2
152	-	-	-	-	-	3.0	144	2.5	2.9	3.3
160	-	-	-	-	-	2.2	152	-	2.1	2.3
							160	-	-	2.0

109.6 ft		32.8 ft			62.3 ft		
ft	0°	20°	40°	0°	20°	40°	
							1,000 lb
20	29.1	-	-	-	-	-	
24	28.7	-	-	14.7	-	-	
28	28.2	-	-	14.6	-	-	
32	27.7	-	-	14.4	-	-	
36	27.1	24.4	-	14.2	-	-	
40	26.6	23.2	19.1	14.1	-	-	
48	25.4	21.1	18.0	13.8	-	-	
56	23.9	19.5	16.8	13.4	12.1	-	
64	21.7	18.1	16.0	13.1	11.6	-	
72	18.6	16.8	15.2	12.8	11.0	8.6	
80	15.9	15.5	14.5	12.3	10.3	8.3	
88	13.3	13.8	13.7	11.6	9.7	8.1	
96	11.2	11.9	12.3	10.8	9.2	7.9	
104	9.8	9.9	10.4	9.8	8.9	7.7	
112	8.5	8.8	-	8.5	8.3	7.7	
120	7.8	7.8	-	7.2	7.8	7.4	
128	7.2	4.5	-	6.4	6.9	7.2	
136	4.1	-	-	5.7	5.9	6.3	
144	-	-	-	4.9	5.3	2.9	
152	-	-	-	4.6	3.2	-	
160	-	-	-	2.3	-	-	

39.4 ft		32.8 ft			62.3 ft		
ft	0°	20°	40°	0°	20°	40°	
							1,000 lb
10	29.1	-	-	21.1	-	-	
12	29.1	-	-	20.9	-	-	
14	29.1	-	-	20.8	-	-	
16	29.1	29.1	-	20.6	-	-	
18	29.1	29.1	-	20.3	-	-	
20	29.1	28.9	-	20.0	-	-	
24	29.1	26.6	-	19.2	-	-	
28	29.1	24.5	20.1	18.5	-	-	
32	28.9	22.8	19.2	17.6	-	-	
36	26.9	21.5	18.4	16.7	13.5	-	
40	24.6	20.3	17.8	15.7	12.7	-	
48	21.1	18.3	16.9	13.8	11.6	-	
56	18.5	17.1	-	12.2	10.4	9.2	
64	-	-	-	11.0	9.6	8.7	
72	-	-	-	9.9	9.1	8.2	
80	-	-	-	9.2	8.6	-	
88	-	-	-	8.6	-	-	



 * 191.9 ft



19,000 lb		26.6 ft x 23.6 ft						360°			ASME B30.5				
194.9 ft		32.8 ft			62.3 ft			179.1 ft		32.8 ft			62.3 ft		
ft		0°	20°	40°	0°	20°	40°*	ft		0°	20°	40°	0°	20°	40°
1,000 lb															
48		8.4	-	-	-	-	-	40		11.0	-	-	-	-	-
56		8.4	-	-	4.9	-	-	48		11.0	-	-	6.4	-	-
64		8.4	8.4	-	4.9	-	-	56		11.0	-	-	6.4	-	-
72		7.7	8.4	-	4.9	-	-	64		10.9	11.0	-	6.4	-	-
80		5.7	7.2	8.1	4.6	4.9	-	72		9.5	10.4	11.0	6.4	-	-
88		4.0	5.4	6.4	3.3	4.9	-	80		7.2	8.7	9.3	5.9	6.4	-
96		2.6	3.8	4.8	2.1	4.2	-	88		5.4	6.6	7.7	4.8	6.1	-
104		-	2.6	3.5	-	3.0	4.9	96		3.9	5.0	6.0	3.5	5.4	6.4
112		-	-	-	-	-	3.7	104		2.8	3.7	4.6	2.3	4.1	5.5
120		-	-	-	-	-	2.6	112		-	2.6	3.2	-	3.0	4.6
								120		-	-	2.2	-	-	3.3
								128		-	-	-	-	-	2.3



109.6 ft		32.8 ft			62.3 ft		
ft		0°	20°	40°	0°	20°	40°
1,000 lb							
20		29.1	-	-	-	-	-
24		28.7	-	-	14.7	-	-
28		28.2	-	-	14.6	-	-
32		27.7	-	-	14.4	-	-
36		27.1	24.4	-	14.2	-	-
40		26.6	23.2	19.1	14.1	-	-
48		24.4	21.1	18.0	13.8	-	-
56		20.0	19.4	16.8	13.4	12.1	-
64		16.4	16.9	16.0	13.1	11.6	-
72		13.3	14.4	14.4	12.8	11.0	8.6
80		11.6	11.7	12.4	11.2	10.3	8.3
88		9.5	10.0	10.1	9.3	9.6	8.1
96		7.8	8.4	8.9	7.9	8.7	7.9
104		6.3	6.8	7.3	6.8	7.4	7.7
112		5.2	5.7	-	5.5	5.9	6.8
120		4.2	4.6	-	4.6	5.5	5.5
128		3.4	3.6	-	3.6	4.4	4.8
136		2.6	-	-	2.8	3.5	3.9
144		-	-	-	2.2	2.7	2.9
152		-	-	-	-	2.1	-



39.4 ft		32.8 ft			62.3 ft		
ft		0°	20°	40°	0°	20°	40°
1,000 lb							
10		29.1	-	-	21.1	-	-
12		29.1	-	-	20.9	-	-
14		29.1	-	-	20.8	-	-
16		29.1	29.1	-	20.6	-	-
18		29.1	29.1	-	20.3	-	-
20		29.1	28.9	-	20.0	-	-
24		29.1	26.6	-	19.2	-	-
28		29.1	24.5	20.1	18.5	-	-
32		28.9	22.8	19.2	17.6	-	-
36		26.9	21.5	18.4	16.7	13.5	-
40		24.6	20.3	17.8	15.7	12.7	-
48		21.1	18.3	16.9	13.8	11.6	-
56		18.5	17.1	-	12.2	10.4	9.2
64		-	-	-	11.0	9.6	8.7
72		-	-	-	9.9	9.1	8.2
80		-	-	-	9.2	8.6	-
88		-	-	-	8.6	-	-

 *191.9 ft

13,400 lb		26.6 ft x 23.6 ft		360°			ASME B30.5			
 194.9 ft										
		32.8 ft			62.3 ft			0°	20°	40°*
		0°	20°	40°	0°	20°	40°*			
ft										
1,000 lb										
48	8.4	-	-	-	-	-	-	-	-	-
56	8.4	-	-	4.9	-	-	-	-	-	-
64	8.0	8.4	-	4.9	-	-	-	-	-	-
72	6.0	7.5	-	4.9	-	-	-	-	-	-
80	3.9	5.5	6.9	3.3	4.9	-	-	-	-	-
88	2.4	3.9	5.0	-	4.3	-	-	-	-	-
96	-	2.4	3.4	-	2.8	-	-	-	-	-
104	-	-	2.1	-	-	-	-	-	3.7	-
112	-	-	-	-	-	-	-	-	2.6	-

 179.1 ft										
		32.8 ft			62.3 ft			0°	20°	40°
		0°	20°	40°	0°	20°	40°			
ft										
1,000 lb										
40	11.0	-	-	-	-	-	-	-	-	-
48	11.0	-	-	6.4	-	-	-	-	-	-
56	11.0	-	-	6.4	-	-	-	-	-	-
64	9.7	10.7	-	6.4	-	-	-	-	-	-
72	7.5	9.1	10.1	6.0	-	-	-	-	-	-
80	5.5	7.0	8.1	4.8	6.3	-	-	-	-	-
88	4.0	5.2	6.2	3.3	5.5	-	-	-	-	-
96	2.6	3.7	4.6	2.1	4.2	5.7	-	-	-	-
104	-	2.4	3.3	-	2.8	4.6	-	-	-	-
112	-	-	-	-	-	3.2	-	-	-	-
120	-	-	-	-	-	2.2	-	-	-	-

 109.6 ft										
		32.8 ft			62.3 ft			0°	20°	40°
		0°	20°	40°	0°	20°	40°			
ft										
1,000 lb										
20	29.1	-	-	-	-	-	-	-	-	-
24	28.7	-	-	14.7	-	-	-	-	-	-
28	28.2	-	-	14.6	-	-	-	-	-	-
32	27.7	-	-	14.4	-	-	-	-	-	-
36	27.1	24.4	-	14.2	-	-	-	-	-	-
40	26.4	23.2	19.1	14.1	-	-	-	-	-	-
48	23.1	21.1	18.0	13.8	-	-	-	-	-	-
56	18.5	18.6	16.8	13.4	12.1	-	-	-	-	-
64	14.9	15.7	15.8	13.1	11.6	-	-	-	-	-
72	12.4	12.9	13.5	11.7	11.0	8.6	-	-	-	-
80	10.0	10.9	10.9	9.8	10.2	8.3	-	-	-	-
88	8.1	8.8	9.4	8.4	9.2	8.1	-	-	-	-
96	6.5	7.1	7.5	6.9	7.8	7.8	-	-	-	-
104	5.2	5.7	5.9	5.6	6.5	7.2	-	-	-	-
112	4.1	4.6	-	4.6	5.5	5.9	-	-	-	-
120	3.3	3.6	-	3.6	4.4	5.0	-	-	-	-
128	2.4	2.8	-	2.8	3.4	4.0	-	-	-	-
136	1.9	-	-	2.1	2.6	3.0	-	-	-	-
144	-	-	-	-	2.0	2.2	-	-	-	-

 39.4 ft										
		32.8 ft			62.3 ft			0°	20°	40°
		0°	20°	40°	0°	20°	40°			
ft										
1,000 lb										
10	29.1	-	-	21.1	-	-	-	-	-	-
12	29.1	-	-	20.9	-	-	-	-	-	-
14	29.1	-	-	20.8	-	-	-	-	-	-
16	29.1	29.1	-	20.6	-	-	-	-	-	-
18	29.1	29.1	-	20.3	-	-	-	-	-	-
20	29.1	28.9	-	20.0	-	-	-	-	-	-
24	29.1	26.6	-	19.2	-	-	-	-	-	-
28	29.1	24.5	20.1	18.5	-	-	-	-	-	-
32	28.9	22.8	19.2	17.6	-	-	-	-	-	-
36	26.9	21.5	18.4	16.7	13.5	-	-	-	-	-
40	24.6	20.3	17.8	15.7	12.7	-	-	-	-	-
48	21.1	18.3	16.9	13.8	11.6	-	-	-	-	-
56	18.5	17.1	-	12.2	10.4	9.2	-	-	-	-
64	-	-	-	11.0	9.6	8.7	-	-	-	-
72	-	-	-	9.9	9.1	8.2	-	-	-	-
80	-	-	-	9.2	8.6	-	-	-	-	-
88	-	-	-	8.6	-	-	-	-	-	-

 *191.9 ft

9,500 lb		26.6 ft x 23.6 ft		360°		ASME B30.5	
194.9 ft		32.8 ft		62.3 ft		179.1 ft	
		0°	20°	40°	0°	20°	40°*
ft		1,000 lb			ft	1,000 lb	
48	8.4	-	-	-	-	-	-
56	8.4	-	-	4.9	-	-	-
64	6.7	8.2	-	4.9	-	-	-
72	4.5	6.2	-	3.6	-	-	-
80	2.7	4.2	5.7	-	4.6	-	-
88	-	2.6	3.9	-	3.2	-	-
96	-	-	2.4	-	-	-	-
104	-	-	-	-	-	-	2.8

109.6 ft		32.8 ft		62.3 ft			
		0°	20°	40°	0°	20°	40°
ft		1,000 lb			ft	1,000 lb	
20	29.1	-	-	-	-	-	-
24	28.7	-	-	14.7	-	-	-
28	28.2	-	-	14.6	-	-	-
32	27.7	-	-	14.4	-	-	-
36	27.0	24.4	-	14.2	-	-	-
40	26.2	23.2	19.1	14.1	-	-	-
48	21.3	20.8	18.0	13.8	-	-	-
56	17.3	17.8	16.8	13.4	12.1	-	-
64	14.0	14.6	15.0	12.3	11.6	-	-
72	11.1	11.9	12.4	10.8	11.0	8.6	-
80	8.9	9.8	10.3	9.2	9.9	8.3	-
88	7.2	7.8	8.4	7.5	8.4	8.1	-
96	5.6	6.2	6.7	5.9	6.9	7.7	-
104	4.3	5.0	5.2	4.8	5.9	6.4	-
112	3.3	3.7	-	3.7	4.8	5.5	-
120	2.5	2.8	-	2.9	3.7	4.4	-
128	-	2.0	-	2.1	2.8	3.3	-
136	-	-	-	-	1.9	2.4	-
144	-	-	-	-	-	1.6	-

39.4 ft		32.8 ft		62.3 ft			
		0°	20°	40°	0°	20°	40°
ft		1,000 lb			ft	1,000 lb	
10	29.1	-	-	-	21.1	-	-
12	29.1	-	-	-	20.9	-	-
14	29.1	-	-	-	20.8	-	-
16	29.1	29.1	-	-	20.6	-	-
18	29.1	29.1	-	-	20.3	-	-
20	29.1	28.9	-	-	20.0	-	-
24	29.1	26.6	-	-	19.2	-	-
28	29.1	24.5	20.1	-	18.5	-	-
32	28.9	22.8	19.2	-	17.6	-	-
36	26.9	21.5	18.4	-	16.7	13.5	-
40	24.6	20.3	17.8	-	15.7	12.7	-
48	21.1	18.3	16.9	-	13.8	11.6	-
56	17.6	16.9	-	-	12.2	10.4	9.2
64	-	-	-	-	11.0	9.6	8.7
72	-	-	-	-	9.9	9.1	8.2
80	-	-	-	-	9.2	8.6	-
88	-	-	-	-	8.5	-	-

 * 191.9 ft

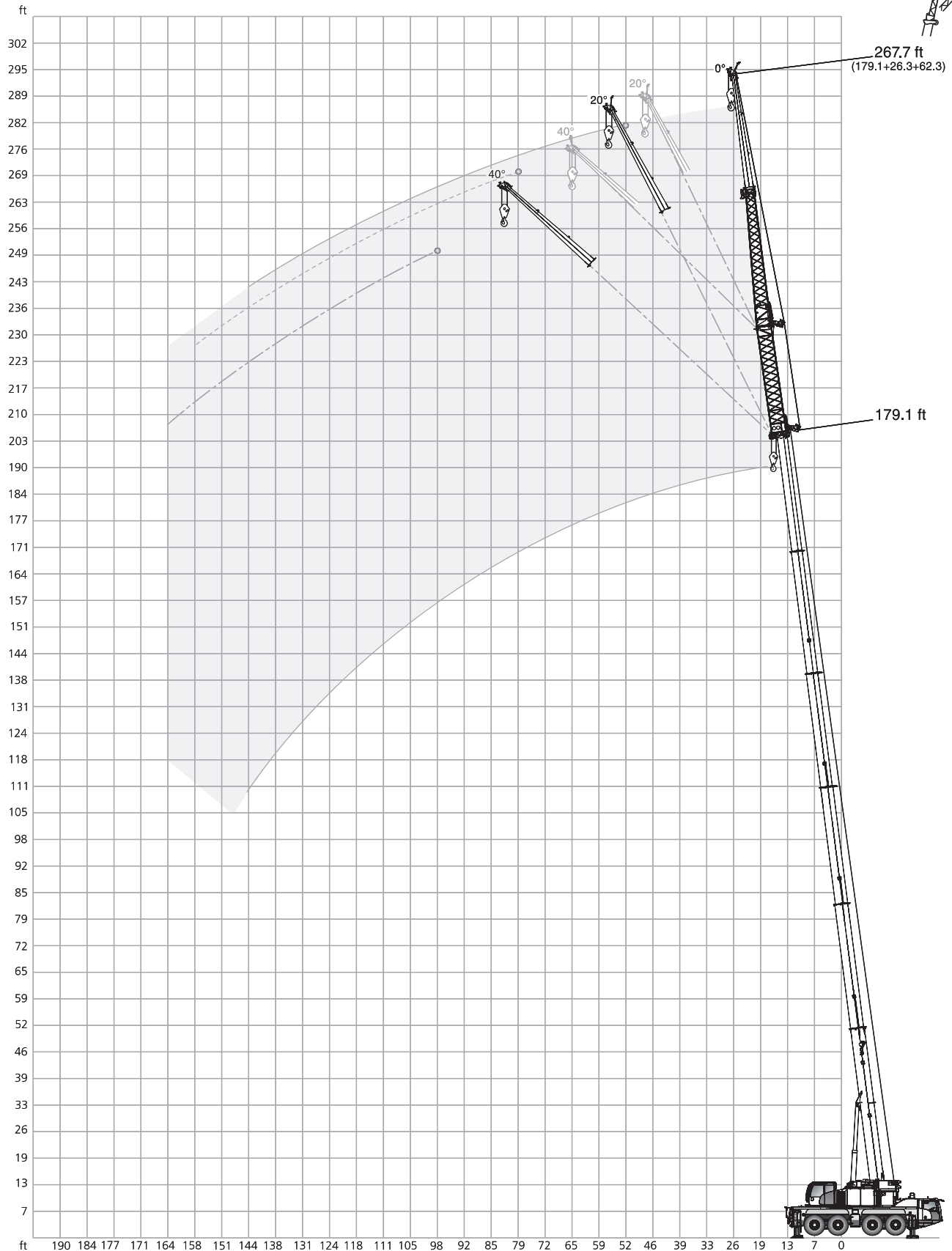
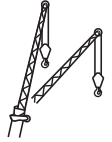

54,000 lb		26.6 ft x 23.6 ft					360°		ASME B30.5				
194.9 ft		26.3 ft					179.1 ft		26.3 ft				
		0°	0°	0°	20°	40°			0°	0°	0°	20°	40°
		62.3 ft							62.3 ft				
		0°	20°	40°*	0°	0°			0°	20°	40°	0°	0°
ft	1,000 lb												
56	4.6	-	-	-	-	-	48	6.6	-	-	-	-	-
64	4.6	-	-	-	-	-	56	6.6	-	-	-	-	-
72	4.6	4.6	-	-	-	-	64	6.6	-	-	-	-	-
80	4.6	4.6	5.1	-	-	-	72	6.6	6.6	-	-	-	-
88	4.6	4.6	5.1	-	-	-	80	6.6	6.6	6.6	6.6	-	-
96	4.6	4.6	5.1	-	-	-	88	6.5	6.6	6.6	6.6	-	-
104	4.6	4.6	5.1	-	-	-	96	6.4	6.5	6.6	6.5	6.5	-
112	4.6	4.6	5.0	-	-	-	104	6.4	6.4	6.6	6.4	6.0	-
120	4.4	4.6	4.6	-	-	-	112	6.1	6.2	6.4	6.2	5.7	-
128	3.5	4.2	4.2	-	-	-	120	5.3	6.0	6.3	6.1	5.7	-
136	2.6	3.5	3.8	-	-	-	128	4.2	5.1	5.7	5.6	5.4	-
144	1.8	2.5	3.3	-	-	-	136	3.8	4.0	4.7	4.7	5.1	-
152	-	-	2.5	-	-	-	144	2.9	3.3	3.6	3.6	4.2	-
							152	2.1	2.8	3.0	2.5	3.2	-
							160	-	-	2.2	-	2.4	-

109.6 ft		26.3 ft				
		0°	0°	0°	20°	40°
		62.3 ft				
		0°	20°	40°	0°	0°
ft	1,000 lb					
24	18.4	-	-	-	-	
28	18.1	-	-	-	-	
32	17.7	-	-	-	-	
36	17.4	-	-	-	-	
40	17.2	16.9	-	-	-	
48	16.5	16.0	14.5	13.9	-	
56	15.9	15.0	13.5	13.1	-	
64	15.2	13.9	12.6	12.1	-	
72	14.1	12.6	11.7	11.3	9.5	
80	13.0	11.7	10.9	10.5	9.0	
88	11.8	10.8	10.2	9.7	8.5	
96	10.8	9.9	9.6	9.2	8.1	
104	10.0	9.3	9.1	8.7	7.7	
112	9.0	8.8	8.6	8.1	7.5	
120	7.7	8.1	7.9	7.7	7.2	
128	6.8	7.2	7.2	7.1	6.9	
136	5.8	6.0	2.3	6.2	6.5	
144	4.7	4.9	-	5.1	-	
152	4.3	-	-	-	-	

39.4 ft		26.3 ft				
		0°	0°	0°	20°	40°
		62.3 ft				
		0°	20°	40°	0°	0°
ft	1,000 lb					
10	29.1	-	-	-	-	
12	29.1	-	-	-	-	
14	29.1	-	-	-	-	
16	29.1	-	-	-	-	
18	28.9	-	-	-	-	
20	28.4	-	-	-	-	
24	25.6	21.9	-	-	-	
28	23.2	20.0	-	-	-	
32	20.9	18.4	16.8	16.3	-	
36	19.2	17.1	15.7	15.2	-	
40	17.6	15.9	14.6	14.2	-	
48	15.2	13.9	13.1	12.7	11.0	
56	13.4	12.4	11.9	11.4	10.0	
64	11.8	11.2	10.8	10.4	9.4	
72	10.6	10.2	10.2	9.5	8.8	
80	9.5	9.4	-	9.0	-	

* 191.9 ft

42,500 lb		26.6 ft x 23.6 ft					360°		ASME B30.5		
194.9 ft		26.3 ft					179.1 ft		26.3 ft		
		0°	0°	0°	20°	40°			0°	0°	
		62.3 ft							62.3 ft		
		0°	20°	40°*	0°	0°			0°	0°	
ft	1,000 lb					ft	1,000 lb				
56	4.6	-	-	-	-	48	6.6	-	-	-	
64	4.6	-	-	-	-	56	6.6	-	-	-	
72	4.6	4.6	-	-	-	64	6.6	-	-	-	
80	4.6	4.6	5.1	-	-	72	6.6	6.6	-	-	
88	4.6	4.6	5.1	-	-	80	6.6	6.6	6.6	6.6	
96	4.6	4.6	5.1	-	-	88	6.5	6.6	6.6	6.6	
104	4.6	4.6	5.1	-	-	96	6.4	6.5	6.6	6.5	
112	3.7	4.6	5.0	-	-	104	5.6	6.4	6.6	6.4	
120	2.6	3.5	4.4	-	-	112	5.0	5.4	6.3	6.1	
128	-	2.5	3.4	-	-	120	3.9	4.4	5.0	4.8	
136	-	-	2.4	-	-	128	2.9	3.6	4.1	3.7	
						136	1.9	2.7	3.3	2.7	
						144	-	1.8	2.5	1.8	

109.6 ft		26.3 ft				
		0°	0°	0°	20°	40°
		62.3 ft				
		0°	20°	40°	0°	0°
ft	1,000 lb					
24	18.4	-	-	-	-	
28	18.1	-	-	-	-	
32	17.7	-	-	-	-	
36	17.4	-	-	-	-	
40	17.2	16.9	-	-	-	
48	16.5	16.0	14.5	13.9	-	
56	15.9	15.0	13.5	13.1	-	
64	15.2	13.9	12.6	12.1	-	
72	14.1	12.6	11.7	11.3	9.5	
80	13.0	11.7	10.9	10.5	9.0	
88	11.6	10.8	10.2	9.7	8.5	
96	10.5	9.9	9.6	9.2	8.1	
104	9.0	9.1	9.1	8.7	7.7	
112	7.4	8.1	8.3	7.9	7.5	
120	6.2	6.7	7.0	7.0	7.1	
128	5.5	5.5	5.6	5.7	6.3	
136	4.7	5.0	2.3	5.0	5.0	
144	4.2	4.2	-	4.2	-	
152	3.7	-	-	-	-	

39.4 ft		26.3 ft				
		0°	0°	0°	20°	40°
		62.3 ft				
		0°	20°	40°	0°	0°
ft	1,000 lb					
10	29.1	-	-	-	-	
12	29.1	-	-	-	-	
14	29.1	-	-	-	-	
16	29.1	-	-	-	-	
18	28.9	-	-	-	-	
20	28.4	-	-	-	-	
24	25.6	21.9	-	-	-	
28	23.2	20.0	-	-	-	
32	20.9	18.4	16.8	16.3	-	
36	19.2	17.1	15.7	15.2	-	
40	17.6	15.9	14.6	14.2	-	
48	15.2	13.9	13.1	12.7	11.0	
56	13.4	12.4	11.9	11.4	10.0	
64	11.8	11.2	10.8	10.4	9.4	
72	10.6	10.2	10.2	9.5	8.8	
80	9.5	9.4	-	9.0	-	



 *191.9 ft

19,000 lb		26.6 ft x 23.6 ft					360°		ASME B30.5				
194.9 ft							179.1 ft						
		26.3 ft							26.3 ft				
		0° 0° 0° 20° 40°							0° 0° 0° 20° 40°				
		62.3 ft							62.3 ft				
		0° 20° 40°* 0° 0°							0° 20° 40° 0° 0°				
ft	1,000 lb					ft	1,000 lb						
56	4.6	-	-	-	-	48	6.6	-	-	-	-		
64	4.6	-	-	-	-	56	6.6	-	-	-	-		
72	4.6	4.6	-	-	-	64	6.6	-	-	-	-		
80	3.7	4.5	5.1	-	-	72	6.6	6.6	-	-	-		
88	-	3.6	4.8	-	-	80	5.4	6.3	6.6	6.5	-		
96	-	2.2	3.6	-	-	88	3.6	5.1	5.8	5.5	-		
104	-	-	2.2	-	-	96	2.2	3.5	4.7	3.9	5.8		
						104	-	2.2	3.3	2.6	4.2		
						112	-	-	-	-	2.8		

109.6 ft						
		26.3 ft				
		0° 0° 0° 20° 40°				
		62.3 ft				
		0° 20° 40° 0° 0°				
ft	1,000 lb					
24	18.4	-	-	-	-	
28	18.1	-	-	-	-	
32	17.7	-	-	-	-	
36	17.4	-	-	-	-	
40	17.2	16.9	-	-	-	
48	16.5	16.0	14.5	13.9	-	
56	15.9	15.0	13.5	13.1	-	
64	14.7	13.9	12.6	12.1	-	
72	12.2	12.6	11.7	11.3	9.5	
80	10.4	10.9	10.8	10.4	9.0	
88	8.2	9.2	9.6	9.3	8.5	
96	7.0	7.3	8.1	7.8	8.0	
104	5.7	6.3	6.4	6.2	7.2	
112	4.3	5.0	5.4	5.5	5.7	
120	3.3	3.9	4.2	4.4	4.8	
128	2.5	3.0	3.2	3.3	3.7	
136	1.7	2.2	2.3	2.4	2.7	

39.4 ft						
		26.3 ft				
		0° 0° 0° 20° 40°				
		62.3 ft				
		0° 20° 40° 0° 0°				
ft	1,000 lb					
10	29.1	-	-	-	-	
12	29.1	-	-	-	-	
14	29.1	-	-	-	-	
16	29.1	-	-	-	-	
18	28.9	-	-	-	-	
20	28.4	-	-	-	-	
24	25.6	21.9	-	-	-	
28	23.2	20.0	-	-	-	
32	20.9	18.4	16.8	16.3	-	
36	19.2	17.1	15.7	15.2	-	
40	17.6	15.9	14.6	14.2	-	
48	15.2	13.9	13.1	12.7	11.0	
56	13.4	12.4	11.9	11.4	10.0	
64	11.8	11.2	10.8	10.4	9.4	
72	10.6	10.2	10.2	9.5	8.8	
80	9.5	9.4	-	9.0	-	



 * 191.9 ft

13,400 lb		26.3 ft x 23.6 ft					360°		ASME B30.5	
 194.9 ft							 179.1 ft			
		26.3 ft							26.3 ft	
		0° 0° 0° 20° 40°							0° 0° 0° 20° 40°	
		62.3 ft							62.3 ft	
		0° 20° 40°* 0° 0°							0° 20° 40° 0° 0°	
ft		1,000 lb					ft		1,000 lb	
56	4.6	-	-	-	-	-	48	6.6	-	-
64	4.6	-	-	-	-	-	56	6.6	-	-
72	4.0	4.6	-	-	-	-	64	6.6	-	-
80	-	3.9	4.9	-	-	-	72	5.5	6.6	-
88	-	-	3.8	-	-	-	80	3.7	5.2	6.1
96	-	-	2.2	-	-	-	88	-	3.5	4.7
							96	-	2.2	3.3
							104	-	-	1.9
										2.6
										4.5
										3.0

 109.6 ft						
		26.3 ft				
		0° 0° 0° 20° 40°				
		62.3 ft				
		0° 20° 40° 0° 0°				
ft		1,000 lb				
24	18.4	-	-	-	-	-
28	18.1	-	-	-	-	-
32	17.7	-	-	-	-	-
36	17.4	-	-	-	-	-
40	17.2	16.9	-	-	-	-
48	16.5	16.0	14.5	13.9	-	-
56	15.5	15.0	13.5	13.1	-	-
64	13.3	13.7	12.6	12.1	-	-
72	11.3	12.1	11.7	11.3	9.5	-
80	8.9	10.0	10.4	10.0	9.0	-
88	7.5	8.0	8.6	8.5	8.4	-
96	5.8	6.6	6.8	6.7	7.6	-
104	4.5	5.2	5.7	5.6	6.2	-
112	3.5	3.9	4.3	4.3	5.2	-
120	2.5	2.9	3.3	3.3	3.9	-
128	-	2.1	2.3	2.3	2.9	-
136	-	-	-	-	1.8	-

 39.4 ft						
		26.3 ft				
		0° 0° 0° 20° 40°				
		62.3 ft				
		0° 20° 40° 0° 0°				
ft		1,000 lb				
10	29.1	-	-	-	-	-
12	29.1	-	-	-	-	-
14	29.1	-	-	-	-	-
16	29.1	-	-	-	-	-
18	28.9	-	-	-	-	-
20	28.4	-	-	-	-	-
24	25.6	21.9	-	-	-	-
28	23.2	20.0	-	-	-	-
32	20.9	18.4	16.8	16.3	-	-
36	19.2	17.1	15.7	15.2	-	-
40	17.6	15.9	14.6	14.2	-	-
48	15.2	13.9	13.1	12.7	11.0	-
56	13.4	12.4	11.9	11.4	10.0	-
64	11.8	11.2	10.8	10.4	9.4	-
72	10.6	10.2	10.2	9.5	8.8	-
80	9.5	9.4	-	9.0	-	-



 *191.9 ft

9,500 lb		26.6 ft x 23.6 ft					360°		ASME B30.5	
 194.9 ft							 179.1 ft			
		26.3 ft							26.3 ft	
		0° 0° 0° 20° 40°							0° 0° 0° 20° 40°	
		62.3 ft							62.3 ft	
		0° 20° 40°* 0° 0°							0° 20° 40° 0° 0°	
ft		1,000 lb					ft		1,000 lb	
56	4.6	-	-	-	-	48	6.6	-	-	-
64	4.3	-	-	-	-	56	6.6	-	-	-
72	2.5	4.4	-	-	-	64	6.0	-	-	-
80	-	-	4.3	-	-	72	4.2	6.0	-	-
88	-	-	2.5	-	-	80	-	3.9	5.4	4.6
						88	-	2.4	3.6	3.0
						96	-	-	2.2	-
						104	-	-	-	1.9

 109.6 ft						
		26.3 ft				
		0° 0° 0° 20° 40°				
		62.3 ft				
		0° 20° 40° 0° 0°				
ft		1,000 lb				
24	18.4	-	-	-	-	
28	18.1	-	-	-	-	
32	17.7	-	-	-	-	
36	17.4	-	-	-	-	
40	17.2	16.9	-	-	-	
48	16.4	16.0	14.5	13.9	-	
56	14.6	14.8	13.5	13.1	-	
64	12.3	13.2	12.6	12.1	-	
72	9.9	11.1	11.5	11.0	9.5	
80	8.3	8.7	9.8	9.6	9.0	
88	6.5	7.3	7.5	7.5	8.1	
96	4.9	5.8	6.4	6.1	6.9	
104	3.7	4.4	4.8	4.8	5.5	
112	2.6	3.2	3.7	3.5	4.3	
120	-	2.2	2.6	2.5	3.1	
128	-	-	-	-	2.1	



 39.4 ft						
		26.3 ft				
		0° 0° 0° 20° 40°				
		62.3 ft				
		0° 20° 40° 0° 0°				
ft		1,000 lb				
10	29.1	-	-	-	-	
12	29.1	-	-	-	-	
14	29.1	-	-	-	-	
16	29.1	-	-	-	-	
18	28.9	-	-	-	-	
20	28.4	-	-	-	-	
24	25.6	21.9	-	-	-	
28	23.2	20.0	-	-	-	
32	20.9	18.4	16.8	16.3	-	
36	19.2	17.1	15.7	15.2	-	
40	17.6	15.9	14.6	14.2	-	
48	15.2	13.9	13.1	12.7	11.0	
56	13.4	12.4	11.9	11.4	10.0	
64	11.8	11.2	10.8	10.4	9.4	
72	10.6	10.2	10.2	9.5	8.8	
80	9.4	9.3	-	9.0	-	

 *191.9 ft

54,000 lb		26.6 ft x 23.6 ft					360°		ASME B30.5				
 179.1 ft							 109.6 ft						
		26.3 ft							26.3 ft				
		0° 0° 0° 20° 40°							0° 0° 0° 20° 40°				
		32.8 ft							32.8 ft				
		0° 20° 40°* 0°* 0°**							0° 20° 40° 0° 0°				
ft		1,000 lb					ft		1,000 lb				
56	3.5	-	-	-	-	-	32	10.1	-	-	-	-	
64	3.5	-	-	-	-	-	36	10.0	-	-	-	-	
72	3.5	-	-	-	-	-	40	9.9	-	-	-	-	
80	3.5	3.5	-	-	-	-	48	9.6	-	-	-	-	
88	3.5	3.5	-	5.0	-	-	56	9.4	-	-	-	-	
96	3.5	3.5	-	4.9	-	-	64	9.1	8.9	-	-	-	
104	3.3	3.5	5.1	4.9	-	-	72	8.8	8.4	-	7.5	-	
112	3.3	3.3	4.9	4.6	4.6	-	80	8.6	7.9	7.0	7.2	-	
120	3.3	3.3	4.9	4.6	4.4	-	88	8.3	7.4	6.7	6.7	5.4	
128	3.3	3.3	4.9	4.6	4.3	-	96	7.9	7.0	6.5	6.3	5.2	
136	2.8	3.3	4.9	4.5	4.2	-	104	7.3	6.6	6.2	6.0	4.9	
144	2.0	3.1	4.6	4.0	4.2	-	112	6.8	6.2	5.7	5.7	4.8	
152	-	2.5	3.6	3.2	3.9	-	120	6.3	5.8	5.4	5.2	4.6	
160	-	-	2.7	2.2	3.3	-	128	5.9	5.4	5.2	5.0	4.4	
							136	5.4	5.1	4.9	4.7	4.2	
							144	4.9	4.9	4.6	4.4	4.2	
							152	4.3	4.5	4.5	4.2	4.2	
							160	3.5	4.0	4.2	4.1	4.0	
							168	2.8	3.3	-	3.6	-	
							176	2.5	2.5	-	2.8	-	





 39.4 ft						
		26.3 ft				
		0° 0° 0° 20° 40°				
		32.8 ft				
		0° 20° 40° 0° 0°				
ft		1,000 lb				
14	17.2	-	-	-	-	
16	17.2	-	-	-	-	
18	17.1	-	-	-	-	
20	16.9	-	-	-	-	
24	16.3	-	-	-	-	
28	15.5	-	-	-	-	
32	14.7	-	-	-	-	
36	13.9	-	-	-	-	
40	13.1	11.8	-	-	-	
48	11.6	10.5	-	9.6	-	
56	10.2	9.2	8.7	8.6	-	
64	9.0	8.3	7.9	7.7	-	
72	8.0	7.5	7.1	7.1	-	
80	7.2	6.7	6.5	6.3	5.6	
88	6.6	6.2	6.0	5.8	5.2	
96	5.9	5.7	5.6	5.2	4.8	
104	5.4	5.3	-	4.9	4.6	
112	4.8	-	-	-	-	





 * 165.4 ft ** 151.6 ft





42,500 lb		26.6 ft x 23.6 ft					360°		ASME B30.5	
 179.1 ft							 109.6 ft			
		26.3 ft							26.3 ft	
		0° 0° 0° 20° 40°							0° 0° 0° 20° 40°	
		32.8 ft							32.8 ft	
		0° 20° 40°* 0°* 0°**							0° 20° 40° 0° 0°	
ft		1,000 lb					ft		1,000 lb	
56	3.5	-	-	-	-	32	10.1	-	-	-
64	3.5	-	-	-	-	36	10.0	-	-	-
72	3.5	-	-	-	-	40	9.9	-	-	-
80	3.5	3.5	-	-	-	48	9.6	-	-	-
88	3.5	3.5	-	5.0	-	56	9.4	-	-	-
96	3.5	3.5	-	4.9	-	64	9.1	8.9	-	-
104	3.3	3.5	5.1	4.9	-	72	8.8	8.4	-	7.5
112	3.3	3.3	4.9	4.6	4.6	80	8.6	7.9	7.0	7.2
120	2.8	3.3	4.9	4.6	4.4	88	8.3	7.4	6.7	6.7
128	-	3.2	4.7	4.2	4.3	96	7.9	7.0	6.5	6.3
136	-	2.4	4.0	3.1	4.2	104	7.3	6.6	6.2	6.0
144	-	1.6	2.9	2.2	4.0	112	6.8	6.2	5.7	5.7
152	-	-	-	-	2.9	120	6.2	5.8	5.4	5.2
						128	5.3	5.4	5.2	5.0
						136	4.4	5.1	4.9	4.7
						144	3.8	4.4	4.6	4.4
						152	3.4	3.7	3.9	3.6
						160	2.7	3.1	3.2	3.1
						168	-	2.5	-	2.6
						176	-	1.9	-	2.1

 39.4 ft						
		26.3 ft				
		0° 0° 0° 20° 40°				
		32.8 ft				
		0° 20° 40° 0° 0°				
ft		1,000 lb				
14	17.2	-	-	-	-	
16	17.2	-	-	-	-	
18	17.1	-	-	-	-	
20	16.9	-	-	-	-	
24	16.3	-	-	-	-	
28	15.5	-	-	-	-	
32	14.7	-	-	-	-	
36	13.9	-	-	-	-	
40	13.1	11.8	-	-	-	
48	11.6	10.5	-	9.6	-	
56	10.2	9.2	8.7	8.6	-	
64	9.0	8.3	7.9	7.7	-	
72	8.0	7.5	7.1	7.1	-	
80	7.2	6.7	6.5	6.3	5.6	
88	6.6	6.2	6.0	5.8	5.2	
96	5.9	5.7	5.6	5.2	4.8	
104	5.4	5.3	-	4.9	4.6	
112	4.8	-	-	-	-	



 * 165.4 ft ** 151.6 ft

19,000 lb		26.6 ft x 23.6 ft		360°		ASME B30.5	
 179.1 ft		26.3 ft		26.3 ft		26.3 ft	
 		0°	0°	0°	20°	40°	
 		0°	20°	40°*	0°*	0°**	
ft	1,000 lb						
56	3.5	-	-	-	-	-	
64	3.5	-	-	-	-	-	
72	3.5	-	-	-	-	-	
80	3.4	3.5	-	-	-	-	
88	2.4	3.5	-	5.0	-	-	
96	-	3.2	-	4.4	-	-	
104	-	2.2	4.5	3.3	-	-	
112	-	-	3.0	-	-	4.6	
120	-	-	-	-	-	3.5	
128	-	-	-	-	-	2.4	

 39.4 ft		26.3 ft		26.3 ft		26.3 ft	
 		0°	0°	0°	20°	40°	
 		0°	20°	40°	0°	0°	
ft	1,000 lb						
14	17.2	-	-	-	-	-	
16	17.2	-	-	-	-	-	
18	17.1	-	-	-	-	-	
20	16.9	-	-	-	-	-	
24	16.3	-	-	-	-	-	
28	15.5	-	-	-	-	-	
32	14.7	-	-	-	-	-	
36	13.9	-	-	-	-	-	
40	13.1	11.8	-	-	-	-	
48	11.6	10.5	-	9.6	-	-	
56	10.2	9.2	8.7	8.6	-	-	
64	9.0	8.3	7.9	7.7	-	-	
72	8.0	7.5	7.1	7.1	-	-	
80	7.2	6.7	6.5	6.3	5.6	-	
88	6.6	6.2	6.0	5.8	5.2	-	
96	5.9	5.7	5.6	5.2	4.8	-	
104	5.4	5.3	-	4.9	4.6	-	
112	4.8	-	-	-	-	-	



 109.6 ft		26.3 ft		26.3 ft		26.3 ft	
 		0°	0°	0°	20°	40°	
 		0°	20°	40°	0°	0°	
ft	1,000 lb						
32	10.1	-	-	-	-	-	
36	10.0	-	-	-	-	-	
40	9.9	-	-	-	-	-	
48	9.6	-	-	-	-	-	
56	9.4	-	-	-	-	-	
64	9.1	8.9	-	-	-	-	
72	8.8	8.4	-	7.5	-	-	
80	8.5	7.9	7.0	7.2	-	-	
88	7.6	7.4	6.7	6.7	5.4	-	
96	6.6	6.9	6.5	6.3	5.2	-	
104	5.4	6.4	6.2	6.0	4.9	-	
112	4.6	5.5	5.7	5.5	4.8	-	
120	3.7	4.4	5.3	4.6	4.6	-	
128	2.8	3.5	4.2	3.6	4.2	-	
136	1.9	2.8	3.1	2.7	3.3	-	
144	-	2.0	2.2	1.8	2.3	-	

 * 165.4 ft ** 151.6 ft

13,400 lb		26.6 ft x 23.6 ft					360°		ASME B30.5				
 179.1 ft							 109.6 ft						
		26.3 ft							26.3 ft				
		0°	0°	0°	20°	40°			0°	0°	0°	20°	40°
		32.8 ft							32.8 ft				
		0°	20°	40°*	0°*	0°**			0°	20°	40°	0°	0°
ft		1,000 lb					ft		1,000 lb				
56	3.5	-	-	-	-	-	32	10.1	-	-	-	-	-
64	3.5	-	-	-	-	-	36	10.0	-	-	-	-	-
72	3.5	-	-	-	-	-	40	9.9	-	-	-	-	-
80	-	3.5	-	-	-	-	48	9.6	-	-	-	-	-
88	-	3.3	-	4.7	-	-	56	9.4	-	-	-	-	-
96	-	2.2	-	3.4	-	-	64	9.1	8.9	-	-	-	-
104	-	-	3.3	1.9	-	-	72	8.8	8.4	-	7.5	-	-
112	-	-	-	-	3.7	-	80	7.9	7.9	7.0	7.2	-	-
120	-	-	-	-	2.4	-	88	6.7	7.3	6.7	6.7	5.4	-
							96	5.7	6.7	6.5	6.3	5.2	-
							104	4.8	5.7	6.0	5.8	4.9	-
							112	3.7	4.4	5.7	4.8	4.8	-
							120	2.7	3.8	4.4	3.7	4.4	-
							128	1.9	2.9	3.3	2.8	3.5	-
							136	-	1.9	2.2	1.8	2.4	-

 39.4 ft						
		26.3 ft				
		0°	0°	0°	20°	40°
		32.8 ft				
		0°	20°	40°	0°	0°
ft		1,000 lb				
14	17.2	-	-	-	-	-
16	17.2	-	-	-	-	-
18	17.1	-	-	-	-	-
20	16.9	-	-	-	-	-
24	16.3	-	-	-	-	-
28	15.5	-	-	-	-	-
32	14.7	-	-	-	-	-
36	13.9	-	-	-	-	-
40	13.1	11.8	-	-	-	-
48	11.6	10.5	-	9.6	-	-
56	10.2	9.2	8.7	8.6	-	-
64	9.0	8.3	7.9	7.7	-	-
72	8.0	7.5	7.1	7.1	-	-
80	7.2	6.7	6.5	6.3	5.6	-
88	6.6	6.2	6.0	5.8	5.2	-
96	5.9	5.7	5.6	5.2	4.8	-
104	5.4	5.3	-	4.9	4.6	-
112	4.8	-	-	-	-	-

 *165.4 ft ** 151.6 ft





9,500 lb		26.6 ft x 23.6 ft					360°		ASME B30.5				
 179.1 ft							 109.6 ft						
		26.3 ft							26.3 ft				
		0° 0° 0° 20° 40°							0° 0° 0° 20° 40°				
		32.8 ft							32.8 ft				
		0° 20° 40°* 0°* 0°**							0° 20° 40° 0° 0°				
ft		1,000 lb					ft		1,000 lb				
56	3.5	-	-	-	-	-	32	10.1	-	-	-	-	
64	3.5	-	-	-	-	-	36	10.0	-	-	-	-	
72	2.7	-	-	-	-	-	40	9.9	-	-	-	-	
80	-	3.4	-	-	-	-	48	9.6	-	-	-	-	
88	-	2.4	-	3.9	-	-	56	9.4	-	-	-	-	
96	-	-	-	2.4	-	-	64	9.1	8.9	-	-	-	
104	-	-	2.2	-	-	-	72	8.4	8.4	-	7.5	-	
112	-	-	-	-	2.8	-	80	7.2	7.8	7.0	7.2	-	
							88	6.0	7.1	6.7	6.7	5.4	
							96	4.8	6.0	6.5	6.0	5.2	
							104	3.7	4.7	6.0	5.2	4.9	
							112	2.8	4.1	4.8	3.9	4.8	
							120	-	3.1	3.5	2.9	3.9	
							128	-	2.1	2.5	2.1	2.6	



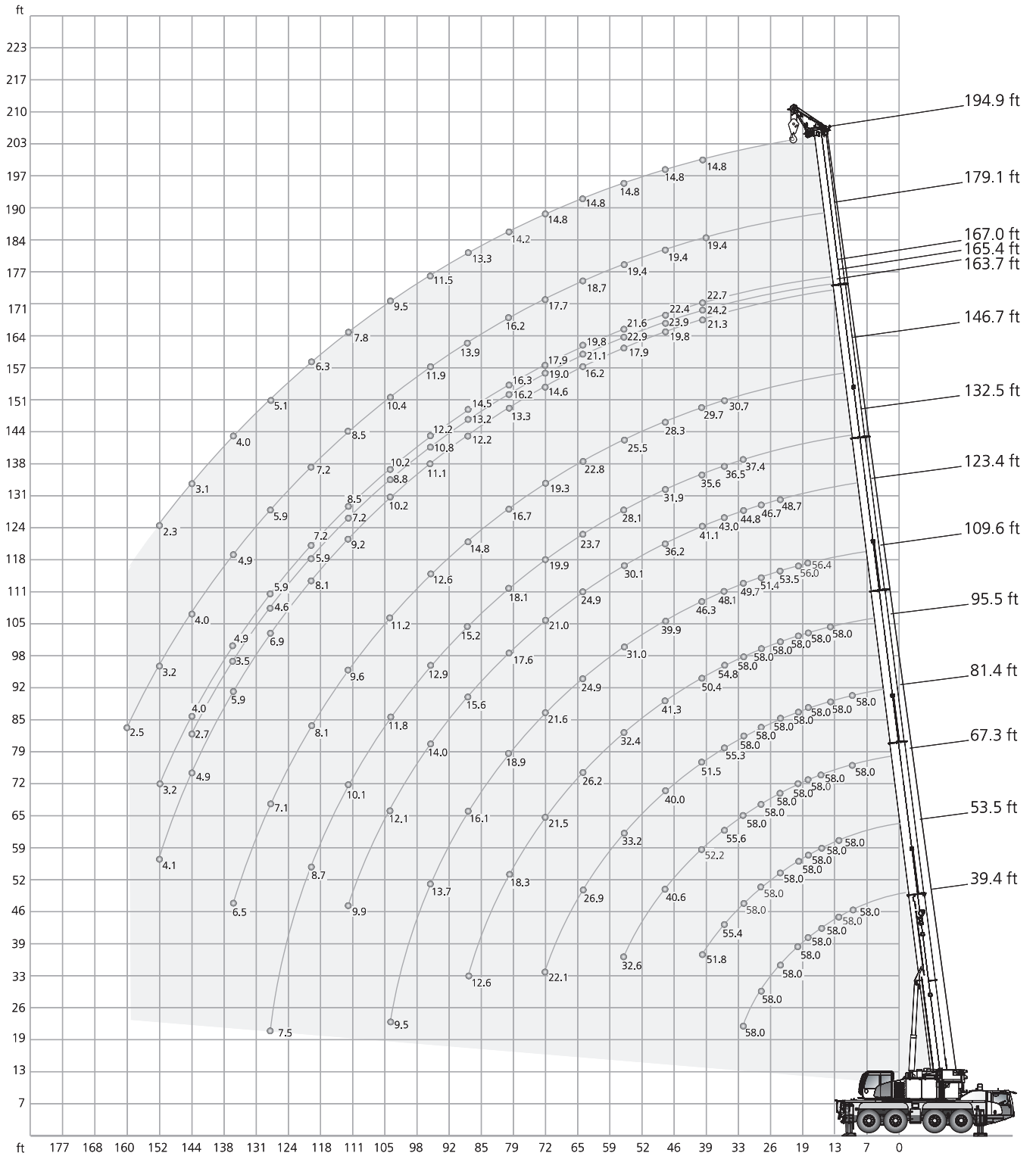
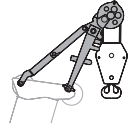

 39.4 ft						
		26.3 ft				
		0° 0° 0° 20° 40°				
		32.8 ft				
		0° 20° 40° 0° 0°				
ft		1,000 lb				
14	17.2	-	-	-	-	-
16	17.2	-	-	-	-	-
18	17.1	-	-	-	-	-
20	16.9	-	-	-	-	-
24	16.3	-	-	-	-	-
28	15.5	-	-	-	-	-
32	14.7	-	-	-	-	-
36	13.9	-	-	-	-	-
40	13.1	11.8	-	-	-	-
48	11.6	10.5	-	9.6	-	-
56	10.2	9.2	8.7	8.6	-	-
64	9.0	8.3	7.9	7.7	-	-
72	8.0	7.5	7.1	7.1	-	-
80	7.2	6.7	6.5	6.3	5.6	-
88	6.6	6.2	6.0	5.8	5.2	-
96	5.9	5.7	5.6	5.2	4.8	-
104	5.4	5.3	-	4.9	4.6	-
112	4.8	-	-	-	-	-





 *165.4 ft ** 151.6 ft





A large rectangular area with horizontal lines, intended for taking notes.







 54,000 lb		 26.6 ft x 23.6 ft														360°		ASME B30.5	
 		(ft)																	
ft		39.4	53.5	67.3	81.4	95.5	109.6	123.4	132.5	146.7	163.7	165.4	167.0	179.1	194.9	ft			
		1,000 lb																	
10		58.0	58.0	58.0	58.0	-	-	-	-	-	-	-	-	-	-	-	10		
12		58.0	58.0	58.0	58.0	-	-	-	-	-	-	-	-	-	-	-	12		
14		58.0	58.0	58.0	58.0	58.0	-	-	-	-	-	-	-	-	-	-	14		
16		58.0	58.0	58.0	58.0	58.0	-	-	-	-	-	-	-	-	-	-	16		
18		58.0	58.0	58.0	58.0	58.0	56.4	-	-	-	-	-	-	-	-	-	18		
20		58.0	58.0	58.0	58.0	58.0	56.0	-	-	-	-	-	-	-	-	-	20		
24		58.0	58.0	58.0	58.0	58.0	53.5	48.7	-	-	-	-	-	-	-	-	24		
28		58.0	58.0	58.0	58.0	58.0	51.4	46.7	-	-	-	-	-	-	-	-	28		
32		58.0	58.0	58.0	58.0	58.0	49.7	44.8	37.4	-	-	-	-	-	-	-	32		
36		-	55.4	55.6	55.3	54.8	48.1	43.0	36.5	30.7	21.5	24.3	22.7	-	-	-	36		
40		-	51.8	52.2	51.5	50.4	46.3	41.1	35.6	29.7	21.3	24.2	22.7	19.4	14.8	-	40		
48		-	-	40.6	40.0	41.3	39.9	36.2	31.9	28.3	19.8	23.9	22.4	19.4	14.8	-	48		
56		-	-	32.6	33.2	32.4	31.0	30.1	28.1	25.5	17.9	22.9	21.6	19.4	14.8	-	56		
64		-	-	-	26.9	26.2	24.9	24.9	23.7	22.8	16.2	21.1	19.8	18.7	14.8	-	64		
72		-	-	-	22.1	21.5	21.6	21.0	19.9	19.3	14.6	19.0	17.9	17.7	14.8	-	72		
80		-	-	-	-	18.3	18.9	17.6	18.1	16.7	13.3	16.2	16.3	16.2	14.2	-	80		
88		-	-	-	-	12.6	16.1	15.6	15.2	14.8	12.2	13.2	14.5	13.9	13.3	-	88		
96		-	-	-	-	-	13.7	14.0	12.9	12.6	11.1	10.8	12.2	11.9	11.5	-	96		
104		-	-	-	-	-	9.5	12.1	11.8	11.2	10.2	8.8	10.2	10.4	9.5	-	104		
112		-	-	-	-	-	-	9.9	10.1	9.6	9.2	7.2	8.5	8.5	7.8	-	112		
120		-	-	-	-	-	-	-	8.7	8.1	8.1	5.9	7.2	7.2	6.3	-	120		
128		-	-	-	-	-	-	-	7.5	7.1	6.9	4.6	5.9	5.9	5.1	-	128		
136		-	-	-	-	-	-	-	-	6.5	5.9	3.5	4.9	4.9	4.0	-	136		
144		-	-	-	-	-	-	-	-	4.9	4.9	2.7	4.0	4.0	3.1	-	144		
152		-	-	-	-	-	-	-	-	-	4.1	-	3.2	3.2	2.3	-	152		
160		-	-	-	-	-	-	-	-	-	-	-	-	2.5	-	-	160		

 42,500 lb		 26.6 ft x 23.6 ft														360°		ASME B30.5	
 ft	 ft	39.4	53.5	67.3	81.4	95.5	109.6	(ft)		123.4	132.5	146.7	163.7	165.4	167.0	179.1	194.9	 ft	
		1,000 lb																	
10		58.0	58.0	58.0	58.0	-	-	-	-	-	-	-	-	-	-	-	-	10	
12		58.0	58.0	58.0	58.0	-	-	-	-	-	-	-	-	-	-	-	-	12	
14		58.0	58.0	58.0	58.0	58.0	-	-	-	-	-	-	-	-	-	-	-	14	
16		58.0	58.0	58.0	58.0	58.0	-	-	-	-	-	-	-	-	-	-	-	16	
18		58.0	58.0	58.0	58.0	58.0	56.4	-	-	-	-	-	-	-	-	-	-	18	
20		58.0	58.0	58.0	58.0	58.0	56.0	-	-	-	-	-	-	-	-	-	-	20	
24		58.0	58.0	58.0	58.0	58.0	53.5	48.7	-	-	-	-	-	-	-	-	-	24	
28		58.0	58.0	58.0	58.0	58.0	51.4	46.7	-	-	-	-	-	-	-	-	-	28	
32		58.0	58.0	58.0	58.0	58.0	49.7	44.8	37.4	-	-	-	-	-	-	-	-	32	
36		-	53.2	53.3	52.9	52.2	48.1	43.0	36.5	30.7	21.5	24.3	22.7	-	-	-	-	36	
40		-	47.0	47.3	46.6	47.1	45.8	40.9	35.6	29.7	21.3	24.2	22.7	19.4	14.8	-	-	40	
48		-	-	35.9	36.9	36.1	34.5	33.8	31.5	28.3	19.8	23.9	22.4	19.4	14.8	-	-	48	
56		-	-	29.0	28.8	28.1	27.1	26.6	25.9	24.9	17.9	22.9	21.6	19.4	14.8	-	-	56	
64		-	-	-	23.2	22.4	22.9	22.0	21.8	20.8	16.2	20.3	19.8	18.7	14.8	-	-	64	
72		-	-	-	19.0	19.7	19.0	18.6	18.2	18.1	14.6	16.4	17.7	17.0	14.8	-	-	72	
80		-	-	-	-	16.8	15.9	16.3	15.4	15.1	13.3	13.2	14.6	14.0	13.3	-	-	80	
88		-	-	-	-	9.9	14.1	13.7	13.5	13.1	12.2	10.5	12.0	12.0	10.9	-	-	88	
96		-	-	-	-	-	12.3	11.7	11.4	10.8	10.7	8.4	9.8	9.8	8.9	-	-	96	
104		-	-	-	-	-	8.0	10.3	9.7	9.1	9.0	6.6	7.9	7.9	7.3	-	-	104	
112		-	-	-	-	-	-	8.8	8.1	8.1	7.4	5.0	6.5	6.5	5.7	-	-	112	
120		-	-	-	-	-	-	-	6.8	7.0	6.1	3.9	5.3	5.3	4.4	-	-	120	
128		-	-	-	-	-	-	-	5.7	5.8	5.1	2.8	4.2	4.2	3.3	-	-	128	
136		-	-	-	-	-	-	-	-	4.9	4.1	1.8	3.1	3.3	2.4	-	-	136	
144		-	-	-	-	-	-	-	-	3.3	3.3	-	2.2	2.5	-	-	-	144	
152		-	-	-	-	-	-	-	-	-	2.6	-	-	-	-	-	-	152	



 19,000 lb		 26.6 ft x 23.6 ft														360°		ASME B30.5	
 ft	 ft	39.4	53.5	67.3	81.4	95.5	109.6	(ft)		123.4	132.5	146.7	163.7	165.4	167.0	179.1	194.9	 ft	
		1,000 lb																	
10		58.0	58.0	58.0	58.0	-	-	-	-	-	-	-	-	-	-	-	-	10	
12		58.0	58.0	58.0	58.0	-	-	-	-	-	-	-	-	-	-	-	-	12	
14		58.0	58.0	58.0	58.0	58.0	-	-	-	-	-	-	-	-	-	-	-	14	
16		58.0	58.0	58.0	58.0	58.0	-	-	-	-	-	-	-	-	-	-	-	16	
18		58.0	58.0	58.0	58.0	58.0	56.4	-	-	-	-	-	-	-	-	-	-	18	
20		58.0	58.0	58.0	58.0	58.0	56.0	-	-	-	-	-	-	-	-	-	-	20	
24		58.0	58.0	58.0	58.0	58.0	53.5	48.7	-	-	-	-	-	-	-	-	-	24	
28		56.0	57.3	57.5	56.5	55.4	50.8	46.7	-	-	-	-	-	-	-	-	-	28	
32		47.1	49.5	49.8	49.9	48.9	45.2	41.7	37.4	-	-	-	-	-	-	-	-	32	
36		-	41.0	41.2	42.8	41.4	39.5	36.5	33.3	30.0	21.5	24.3	22.7	-	-	-	-	36	
40		-	34.5	35.6	35.4	34.5	34.5	32.7	30.4	27.8	21.3	24.0	22.7	19.4	14.8	-	-	40	
48		-	-	26.3	26.2	26.6	26.4	25.8	24.7	23.5	19.8	20.7	21.5	19.0	14.8	-	-	48	
56		-	-	20.2	20.8	20.9	20.5	20.5	20.5	19.5	17.9	16.0	17.5	16.8	14.3	-	-	56	
64		-	-	-	16.9	16.8	16.9	16.7	16.0	15.5	15.0	12.2	13.7	13.3	11.6	-	-	64	
72		-	-	-	13.7	14.0	13.7	13.3	12.8	12.9	11.8	9.1	10.4	10.2	8.7	-	-	72	
80		-	-	-	-	11.3	11.1	10.7	10.9	10.2	9.4	6.7	8.1	7.8	6.3	-	-	80	
88		-	-	-	-	8.3	9.1	8.6	8.8	8.1	7.3	4.7	6.2	5.8	4.5	-	-	88	
96		-	-	-	-	-	7.5	6.9	7.1	6.4	5.7	3.1	4.6	4.4	3.1	-	-	96	
104		-	-	-	-	-	6.1	5.5	5.7	5.0	4.4	1.9	3.3	3.2	1.9	-	-	104	
112		-	-	-	-	-	-	4.4	4.6	3.7	3.0	-	-	-	-	-	-	112	
120		-	-	-	-	-	-	-	3.6	2.8	2.2	-	-	-	-	-	-	120	
128		-	-	-	-	-	-	-	2.0	2.0	-	-	-	-	-	-	-	128	

 13,400 lb		 26.6 ft x 23.6 ft														360°		ASME B30.5	
		(ft)																	
ft	39.4	53.5	67.3	81.4	95.5	109.6	123.4	132.5	146.7	163.7	165.4	167.0	179.1	194.9	ft				
1,000 lb																			
10	58.0	58.0	58.0	58.0	-	-	-	-	-	-	-	-	-	-	10				
12	58.0	58.0	58.0	58.0	-	-	-	-	-	-	-	-	-	-	12				
14	58.0	58.0	58.0	58.0	58.0	-	-	-	-	-	-	-	-	-	14				
16	58.0	58.0	58.0	58.0	58.0	-	-	-	-	-	-	-	-	-	16				
18	58.0	58.0	58.0	58.0	58.0	56.4	-	-	-	-	-	-	-	-	18				
20	58.0	58.0	58.0	58.0	58.0	56.0	-	-	-	-	-	-	-	-	20				
24	58.0	58.0	58.0	58.0	57.6	53.5	48.7	-	-	-	-	-	-	-	24				
28	53.5	54.8	54.9	54.0	53.0	48.9	44.8	36.0	-	-	-	-	-	-	28				
32	43.0	45.2	45.8	46.9	44.8	42.1	39.6	35.6	-	-	-	-	-	-	32				
36	-	37.3	39.4	39.3	37.8	36.7	34.5	31.7	28.4	21.5	24.3	22.7	-	-	36				
40	-	31.4	32.5	32.3	32.1	31.4	30.7	29.0	26.1	21.3	23.8	22.6	19.4	14.8	40				
48	-	-	23.9	24.3	24.8	24.1	24.3	23.7	22.0	19.7	18.1	19.8	18.2	14.8	48				
56	-	-	18.3	19.3	19.0	19.3	19.0	18.4	17.3	16.6	13.4	15.2	14.8	13.0	56				
64	-	-	-	15.3	15.3	15.1	14.9	14.3	14.2	12.8	9.9	11.5	11.1	9.5	64				
72	-	-	-	12.2	12.2	12.0	11.7	11.7	11.1	9.8	7.1	8.7	8.2	6.7	72				
80	-	-	-	-	9.8	9.6	9.2	9.4	8.7	7.6	5.0	6.4	6.1	4.6	80				
88	-	-	-	-	8.1	7.7	7.3	7.4	6.7	5.8	3.2	4.7	4.4	3.0	88				
96	-	-	-	-	-	6.1	5.7	5.8	5.1	4.4	-	3.3	3.1	-	96				
104	-	-	-	-	-	4.8	4.4	4.5	3.9	3.0	-	2.1	1.9	-	104				
112	-	-	-	-	-	-	3.3	3.5	2.8	-	-	-	-	-	112				
120	-	-	-	-	-	-	-	2.5	-	-	-	-	-	-	120				

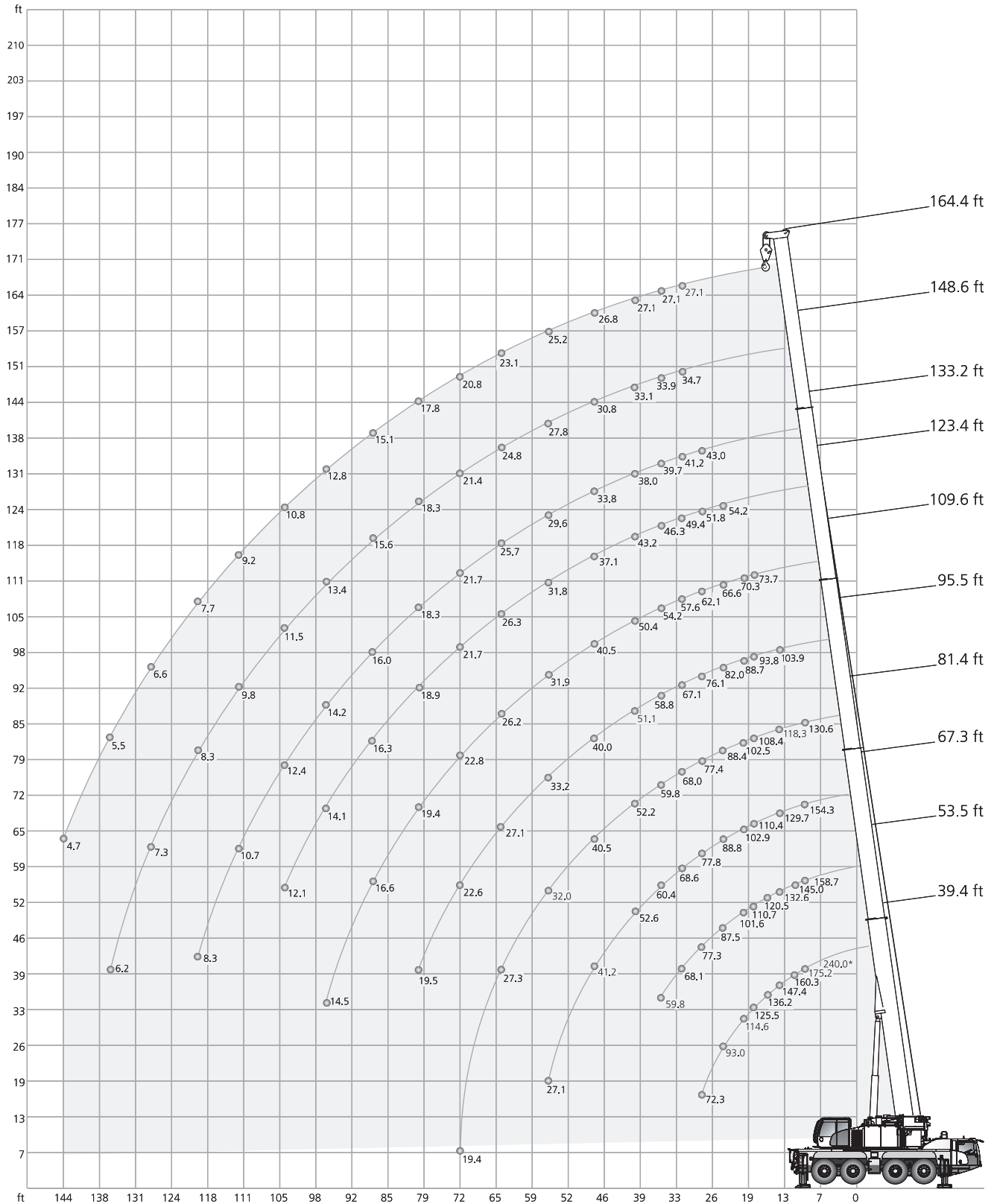
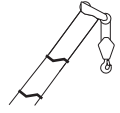
 9,500 lb		 26.6 ft x 23.6 ft														360°		ASME B30.5	
		(ft)																	
ft	39.4	53.5	67.3	81.4	95.5	109.6	123.4	132.5	146.7	163.7	165.4	167.0	179.1	194.9	ft				
1,000 lb																			
10	58.0	58.0	58.0	58.0	-	-	-	-	-	-	-	-	-	-	10				
12	58.0	58.0	58.0	58.0	-	-	-	-	-	-	-	-	-	-	12				
14	58.0	58.0	58.0	58.0	58.0	-	-	-	-	-	-	-	-	-	14				
16	58.0	58.0	58.0	58.0	58.0	-	-	-	-	-	-	-	-	-	16				
18	58.0	58.0	58.0	58.0	58.0	56.4	-	-	-	-	-	-	-	-	18				
20	58.0	58.0	58.0	58.0	58.0	56.0	-	-	-	-	-	-	-	-	20				
24	57.9	58.0	58.0	57.2	56.9	52.6	48.1	-	-	-	-	-	-	-	24				
28	51.5	52.9	53.0	52.4	50.2	46.9	42.8	36.0	-	-	-	-	-	-	28				
32	39.8	42.2	43.7	44.0	41.7	39.8	37.3	34.1	27.8	-	-	-	-	-	32				
36	-	35.2	36.8	36.5	35.3	34.1	32.4	30.5	26.6	21.5	23.4	22.7	-	-	36				
40	-	29.1	30.2	29.9	30.6	30.2	28.8	27.5	24.9	21.3	22.0	22.3	19.2	14.8	40				
48	-	-	22.0	23.1	22.9	22.9	22.9	21.3	19.8	19.1	15.9	17.7	17.1	14.1	48				
56	-	-	17.2	17.6	17.9	17.6	17.4	16.5	16.3	14.8	11.6	13.3	12.8	11.0	56				
64	-	-	-	13.8	13.9	13.7	13.3	13.4	12.6	11.2	8.3	9.9	9.4	7.7	64				
72	-	-	-	10.9	10.9	10.9	10.2	10.4	9.8	8.4	5.6	7.1	6.7	5.1	72				
80	-	-	-	-	8.7	8.5	8.1	8.1	7.4	6.4	3.7	5.0	4.8	3.3	80				
88	-	-	-	-	7.0	6.7	6.3	6.3	5.6	4.7	-	3.5	3.3	-	88				
96	-	-	-	-	-	5.3	4.8	4.8	4.2	3.4	-	2.2	2.0	-	96				
104	-	-	-	-	-	3.9	3.5	3.7	3.0	2.3	-	-	-	-	104				
112	-	-	-	-	-	-	2.6	2.6	-	-	-	-	-	-	112				



* Capacity class

54,000 lb		26.6 ft x 23.6 ft						360°				ASME B30.5	
		(0°)	(ft)										
ft	ft	39.4	39.4	53.5	67.3	81.4	95.5	109.6	123.4	133.2	148.6	164.4	ft
		1,000 lb											
8	240.0 *	-	-	-	-	-	-	-	-	-	-	-	8
10	175.2	162.1	158.7	154.3	130.6	-	-	-	-	-	-	-	10
12	160.3	145.9	145.0	140.9	127.1	-	-	-	-	-	-	-	12
14	147.4	131.7	132.6	129.7	118.3	103.9	-	-	-	-	-	-	14
16	136.2	119.4	120.5	119.8	113.8	99.1	-	-	-	-	-	-	16
18	125.5	109.6	110.7	110.4	108.4	93.8	73.7	-	-	-	-	-	18
20	114.6	100.4	101.6	102.9	102.5	88.7	70.3	-	-	-	-	-	20
24	93.0	86.2	87.5	88.8	88.4	82.0	66.6	54.2	-	-	-	-	24
28	72.3	68.2	77.3	77.8	77.4	76.1	62.1	51.8	43.0	-	-	-	28
32	-	-	68.1	68.6	68.0	67.1	57.6	49.4	41.2	34.7	27.1	32	
36	-	-	59.8	60.4	59.8	58.8	54.2	46.3	39.7	33.9	27.1	36	
40	-	-	-	52.6	52.2	51.1	50.4	43.2	38.0	33.1	27.1	40	
48	-	-	-	41.2	40.5	40.0	40.5	37.1	33.8	30.8	26.8	48	
56	-	-	-	27.1	32.0	33.2	31.9	31.8	29.6	27.8	25.2	56	
64	-	-	-	-	27.3	27.1	26.2	26.3	25.7	24.8	23.1	64	
72	-	-	-	-	19.4	22.6	22.8	21.7	21.7	21.4	20.8	72	
80	-	-	-	-	-	19.5	19.4	18.9	18.3	18.3	17.8	80	
88	-	-	-	-	-	14.0	16.6	16.3	16.0	15.6	15.1	88	
96	-	-	-	-	-	-	14.5	14.1	14.2	13.4	12.8	96	
104	-	-	-	-	-	-	12.8	12.1	12.4	11.5	10.8	104	
112	-	-	-	-	-	-	-	-	10.7	9.8	9.2	112	
120	-	-	-	-	-	-	-	-	8.3	8.3	7.7	120	
128	-	-	-	-	-	-	-	-	-	7.3	6.6	128	
136	-	-	-	-	-	-	-	-	-	6.2	5.5	136	
144	-	-	-	-	-	-	-	-	-	-	4.7	144	

* Capacity class

42,500 lb		26.6 ft x 23.6 ft				360° / Max.*				ASME B30.5	
ft	360° 39.4 ft	Max. 39.4 ft	360° 53.5 ft	Max. 53.5 ft	360° 67.3 ft	Max. 67.3 ft	360° 81.4 ft	Max. 81.4 ft	360° 95.5 ft	Max. 95.5 ft	ft
1,000 lb											
10	161.6	162.1	158.7	158.7	154.3	154.3	130.6	130.6	-	-	10
12	144.8	145.9	144.7	145.0	140.9	140.9	127.1	127.1	-	-	12
14	130.3	131.7	131.4	132.6	129.7	129.7	118.3	118.3	103.9	103.9	14
16	118.1	119.4	119.2	120.5	119.0	119.8	113.8	113.8	99.1	99.1	16
18	108.2	109.6	109.5	110.7	109.3	110.4	107.8	108.4	93.8	93.8	18
20	99.2	100.4	100.5	101.6	101.8	102.9	101.4	102.5	88.7	88.7	20
24	85.3	86.1	86.5	87.5	87.8	88.8	87.3	88.4	82.0	82.0	24
28	67.7	68.0	75.4	76.0	76.0	76.5	75.5	76.0	74.6	74.7	28
32	-	-	64.3	64.9	64.9	65.3	64.5	64.8	63.4	64.0	32
36	-	-	55.2	56.5	55.9	56.9	55.3	56.4	54.1	55.4	36
40	-	-	-	-	47.5	49.2	46.8	48.6	46.2	47.5	40
48	-	-	-	-	35.9	37.4	35.8	36.9	36.6	38.1	48
56	-	-	-	-	24.1	25.8	29.4	30.5	28.9	30.2	56
64	-	-	-	-	-	-	23.9	25.1	23.9	24.6	64
72	-	-	-	-	-	-	19.4	19.4	19.9	21.2	72
80	-	-	-	-	-	-	-	-	17.0	18.1	80
88	-	-	-	-	-	-	-	-	14.0	14.0	88

ft	360° 109.6 ft	Max. 109.6 ft	360° 123.4 ft	Max. 123.4 ft	360° 133.2 ft	Max. 133.2 ft	360° 148.6 ft	Max. 148.6 ft	360° 164.4 ft	Max. 164.4 ft	ft
1,000 lb											
18	73.7	73.7	-	-	-	-	-	-	-	-	18
20	70.3	70.3	-	-	-	-	-	-	-	-	20
24	66.6	66.6	54.2	54.2	-	-	-	-	-	-	24
28	62.1	62.1	51.8	51.8	43.0	43.0	-	-	-	-	28
32	57.6	57.6	49.4	49.4	41.2	41.2	34.7	34.7	27.1	27.1	32
36	52.6	53.5	46.3	46.3	39.7	39.7	33.9	33.9	27.1	27.1	36
40	46.8	48.6	42.9	43.1	38.0	38.0	33.1	33.1	27.1	27.1	40
48	35.3	36.9	35.7	36.3	33.0	33.6	30.8	30.8	26.8	26.8	48
56	28.8	29.5	28.0	29.5	27.7	28.5	26.7	27.6	25.2	25.2	56
64	23.5	24.8	23.1	24.0	22.4	23.7	22.6	23.6	21.8	22.8	64
72	19.5	20.6	19.3	20.4	19.5	19.9	18.6	19.7	17.9	19.3	72
80	16.8	17.7	16.1	17.2	16.3	17.4	15.5	16.6	14.8	16.1	80
88	14.3	15.4	13.6	14.7	13.8	14.9	12.9	14.3	12.4	13.6	88
96	12.3	13.4	11.6	12.7	11.8	12.9	10.9	12.1	10.3	11.6	96
104	10.6	11.7	9.9	11.0	10.1	11.2	9.1	10.3	8.6	9.7	104
112	-	-	-	-	8.7	9.8	7.6	9.0	7.0	8.3	112
120	-	-	-	-	6.4	7.5	6.4	7.7	5.9	7.0	120
128	-	-	-	-	-	-	5.4	6.6	4.7	5.9	128
136	-	-	-	-	-	-	4.6	5.7	3.8	5.0	136
144	-	-	-	-	-	-	-	-	2.9	4.2	144

* Max. values are valid only for specific superstructure positions

19,000 lb		26.6 ft x 23.6 ft				360° / Max.*				ASME B30.5	
ft	360° 39.4 ft	Max. 39.4 ft	360° 53.5 ft	Max. 53.5 ft	360° 67.3 ft	Max. 67.3 ft	360° 81.4 ft	Max. 81.4 ft	360° 95.5 ft	Max. 95.5 ft	ft
1,000 lb											
10	158.8	162.1	158.5	158.7	154.3	154.3	130.6	130.6	-	-	10
12	141.4	145.9	142.5	145.0	140.8	140.9	127.1	127.1	-	-	12
14	127.3	131.7	128.4	132.6	128.2	129.7	118.3	118.3	103.9	103.9	14
16	115.4	119.4	116.5	120.5	116.4	119.8	113.8	113.8	99.1	99.1	16
18	105.6	108.4	106.9	109.7	106.8	109.5	105.4	107.6	93.2	93.8	18
20	96.0	97.6	97.6	99.2	98.9	100.9	95.7	100.5	86.4	88.7	20
24	75.3	79.1	78.7	81.4	79.5	81.9	75.0	81.4	68.5	79.5	24
28	57.9	64.1	61.7	68.0	62.6	68.6	60.6	68.0	58.7	67.0	28
32	-	-	48.6	58.1	49.5	58.5	49.3	58.1	49.9	57.0	32
36	-	-	40.4	50.9	41.3	51.3	42.4	50.9	41.9	50.2	36
40	-	-	-	-	35.2	44.9	35.4	44.4	35.6	45.3	40
48	-	-	-	-	26.3	35.8	26.5	36.0	26.7	36.5	48
56	-	-	-	-	20.2	24.8	20.9	29.9	20.9	29.3	56
64	-	-	-	-	-	-	16.6	24.4	16.9	24.2	64
72	-	-	-	-	-	-	13.5	19.4	13.7	20.6	72
80	-	-	-	-	-	-	-	-	11.3	17.5	80
88	-	-	-	-	-	-	-	-	9.4	14.0	88

ft	360° 109.6 ft	Max. 109.6 ft	360° 123.4 ft	Max. 123.4 ft	360° 133.2 ft	Max. 133.2 ft	360° 148.6 ft	Max. 148.6 ft	360° 164.4 ft	Max. 164.4 ft	ft
1,000 lb											
18	73.7	73.7	-	-	-	-	-	-	-	-	18
20	70.2	70.3	-	-	-	-	-	-	-	-	20
24	63.9	66.6	54.2	54.2	-	-	-	-	-	-	24
28	54.7	62.1	49.1	51.8	43.0	43.0	-	-	-	-	28
32	46.7	57.0	44.5	49.4	39.9	41.2	34.7	34.7	27.1	27.1	32
36	41.0	50.9	38.8	46.3	36.2	39.7	32.6	33.9	27.1	27.1	36
40	35.2	44.4	34.3	42.9	33.6	38.0	31.4	33.1	26.8	27.1	40
48	26.5	35.3	25.8	35.8	26.0	33.1	24.4	30.8	22.7	26.8	48
56	20.6	29.1	19.9	28.4	20.1	28.1	19.3	26.9	17.8	25.2	56
64	16.4	24.0	15.8	23.5	16.0	22.9	15.1	22.9	13.9	22.0	64
72	13.1	20.1	12.6	19.9	12.9	19.9	11.8	19.3	10.9	18.4	72
80	10.7	17.3	10.0	16.6	10.2	16.8	9.2	15.9	8.5	15.5	80
88	8.7	14.9	8.1	14.3	8.3	14.5	7.3	13.6	6.6	13.1	88
96	7.1	12.8	6.4	12.3	6.7	12.4	5.7	11.5	5.0	10.9	96
104	5.9	11.2	5.2	10.6	5.2	10.8	4.4	9.9	3.7	9.6	104
112	-	-	-	-	4.1	9.4	3.2	8.5	2.6	7.9	112
120	-	-	-	-	2.2	7.5	2.2	7.2	-	7.0	120
128	-	-	-	-	-	-	-	6.4	-	5.8	128
136	-	-	-	-	-	-	-	5.5	-	5.0	136
144	-	-	-	-	-	-	-	-	-	4.2	144

* Max. values are valid only for specific superstructure positions

13,400 lb		26.6 ft x 23.6 ft				360° / Max.*				ASME B30.5	
ft	360° 39.4 ft	Max. 39.4 ft	360° 53.5 ft	Max. 53.5 ft	360° 67.3 ft	Max. 67.3 ft	360° 81.4 ft	Max. 81.4 ft	360° 95.5 ft	Max. 95.5 ft	ft
1,000 lb											
10	158.0	162.1	158.5	158.7	154.3	154.3	130.6	130.6	-	-	10
12	140.7	145.9	141.8	145.0	140.5	140.9	127.1	127.1	-	-	12
14	126.6	131.7	127.6	132.6	127.5	129.7	118.3	118.3	103.9	103.9	14
16	114.7	119.4	115.9	120.5	115.8	119.8	113.8	113.8	99.1	99.1	16
18	103.4	107.1	105.1	108.4	105.0	108.2	101.6	106.3	89.7	93.8	18
20	92.2	95.0	95.0	96.6	95.8	98.3	88.1	97.9	79.5	88.6	20
24	71.0	76.8	74.8	79.4	73.9	79.8	68.9	79.4	65.1	78.3	24
28	52.8	63.1	56.6	66.3	57.5	66.7	55.6	66.3	54.6	65.2	28
32	-	-	44.4	56.5	45.6	56.9	46.7	56.5	45.7	55.4	32
36	-	-	36.9	49.4	38.7	49.9	39.1	49.4	38.4	49.6	36
40	-	-	-	-	32.1	43.6	32.3	43.1	32.6	44.2	40
48	-	-	-	-	23.8	34.4	24.4	34.9	24.3	34.7	48
56	-	-	-	-	18.6	22.8	18.8	27.9	19.0	27.4	56
64	-	-	-	-	-	-	14.8	22.9	15.0	23.0	64
72	-	-	-	-	-	-	12.0	19.4	12.0	19.5	72
80	-	-	-	-	-	-	-	-	9.6	16.4	80
88	-	-	-	-	-	-	-	-	7.9	14.0	88

ft	360° 109.6 ft	Max. 109.6 ft	360° 123.4 ft	Max. 123.4 ft	360° 133.2 ft	Max. 133.2 ft	360° 148.6 ft	Max. 148.6 ft	360° 164.4 ft	Max. 164.4 ft	ft
1,000 lb											
18	73.7	73.7	-	-	-	-	-	-	-	-	18
20	69.7	70.3	-	-	-	-	-	-	-	-	20
24	60.8	66.6	53.2	54.2	-	-	-	-	-	-	24
28	50.7	62.1	47.0	51.8	42.4	43.0	-	-	-	-	28
32	44.2	55.8	41.6	49.4	38.5	41.2	34.7	34.7	27.1	27.1	32
36	37.8	49.4	36.3	45.0	34.8	39.7	31.0	33.9	26.9	27.1	36
40	32.2	43.1	31.1	41.6	30.7	37.9	28.3	33.1	26.1	27.1	40
48	24.0	33.8	23.3	33.5	23.7	32.1	21.6	30.3	19.9	26.8	48
56	18.5	27.6	17.8	26.9	18.1	26.3	16.9	25.9	15.3	24.5	56
64	14.4	22.5	13.8	22.2	14.2	22.3	13.1	21.5	11.7	20.7	64
72	11.5	19.2	10.9	18.6	11.1	18.8	10.0	17.9	8.9	17.1	72
80	9.2	16.2	8.5	15.5	8.7	15.7	7.6	14.9	6.8	14.3	80
88	7.4	13.8	6.7	13.4	7.0	13.5	5.8	12.6	5.2	11.8	88
96	5.9	12.0	5.3	11.3	5.3	11.5	4.4	10.6	3.7	9.8	96
104	4.8	10.3	4.1	9.9	4.1	9.9	3.2	9.2	2.6	8.3	104
112	-	-	-	-	3.0	8.7	2.1	7.9	-	7.0	112
120	-	-	-	-	-	6.4	-	6.5	-	5.7	120
128	-	-	-	-	-	-	-	5.3	-	4.6	128
136	-	-	-	-	-	-	-	4.4	-	3.7	136
144	-	-	-	-	-	-	-	-	-	2.9	144

* Max. values are valid only for specific superstructure positions

9,500 lb		26.6 ft x 23.6 ft				360° / Max.*				ASME B30.5	
ft	360° 39.4 ft	Max. 39.4 ft	360° 53.5 ft	Max. 53.5 ft	360° 67.3 ft	Max. 67.3 ft	360° 81.4 ft	Max. 81.4 ft	360° 95.5 ft	Max. 95.5 ft	ft
1,000 lb											
10	157.3	162.1	158.4	158.7	154.3	154.3	130.6	130.6	-	-	10
12	140.1	145.9	141.2	145.0	140.4	140.9	127.1	127.1	-	-	12
14	126.1	131.7	127.2	132.6	127.1	129.7	118.3	118.3	103.9	103.9	14
16	114.3	119.4	115.5	120.5	115.3	119.8	110.3	113.8	97.8	99.1	16
18	101.9	106.1	103.6	107.4	102.1	107.2	96.6	105.4	86.3	93.8	18
20	89.3	93.1	92.8	95.1	90.0	96.4	82.7	95.9	74.7	88.4	20
24	66.0	75.2	70.4	77.7	69.3	78.3	64.6	77.7	62.4	76.7	24
28	48.9	62.4	52.6	64.8	53.6	65.3	53.4	64.8	51.1	63.9	28
32	-	-	41.2	55.3	43.5	55.8	43.7	55.3	43.0	55.0	32
36	-	-	34.1	48.4	36.1	48.9	36.3	48.4	36.5	49.1	36
40	-	-	-	-	29.7	42.5	30.4	42.0	30.2	43.0	40
48	-	-	-	-	22.2	33.3	22.4	33.5	22.7	32.9	48
56	-	-	-	-	16.9	21.6	17.1	26.5	17.3	26.5	56
64	-	-	-	-	-	-	13.4	21.8	13.5	22.0	64
72	-	-	-	-	-	-	10.6	18.6	10.6	18.4	72
80	-	-	-	-	-	-	-	-	8.5	15.5	80
88	-	-	-	-	-	-	-	-	6.8	13.7	88

ft	360° 109.6 ft	Max. 109.6 ft	360° 123.4 ft	Max. 123.4 ft	360° 133.2 ft	Max. 133.2 ft	360° 148.6 ft	Max. 148.6 ft	360° 164.4 ft	Max. 164.4 ft	ft
1,000 lb											
18	73.4	73.7	-	-	-	-	-	-	-	-	18
20	68.7	70.3	-	-	-	-	-	-	-	-	20
24	57.0	66.6	51.4	54.2	41.3	-	-	-	-	-	24
28	48.9	61.4	45.3	51.8	40.5	43.0	33.6	-	-	-	28
32	41.1	55.0	38.9	49.4	37.5	41.2	33.2	34.7	27.1	27.1	32
36	35.2	47.7	33.4	44.2	32.8	39.7	29.7	33.9	25.6	27.1	36
40	30.0	40.9	28.5	40.8	28.1	37.7	25.7	33.1	23.5	27.1	40
48	22.2	33.1	21.4	31.6	21.5	31.1	19.4	29.9	17.8	26.8	48
56	16.7	26.3	16.1	26.0	16.3	25.6	14.8	24.9	13.4	23.8	56
64	13.0	21.4	12.3	21.2	12.6	21.4	11.2	20.4	9.9	19.2	64
72	10.0	18.2	9.5	17.7	9.8	17.9	8.7	17.0	7.3	15.5	72
80	7.9	15.3	7.2	14.8	7.5	14.9	6.5	14.0	5.5	12.6	80
88	6.3	13.3	5.6	12.6	5.8	12.8	4.7	11.8	4.0	10.4	88
96	4.8	11.4	4.2	10.7	4.4	10.9	3.4	9.8	2.8	8.5	96
104	3.9	9.7	3.2	9.0	3.2	9.1	2.3	8.1	-	7.0	104
112	-	-	-	-	2.4	7.6	-	6.6	-	5.7	112
120	-	-	-	-	-	5.3	-	5.5	-	4.7	120
128	-	-	-	-	-	-	-	4.4	-	3.7	128
136	-	-	-	-	-	-	-	3.5	-	2.8	136
144	-	-	-	-	-	-	-	-	-	2.0	144

* Max. values are valid only for specific superstructure positions

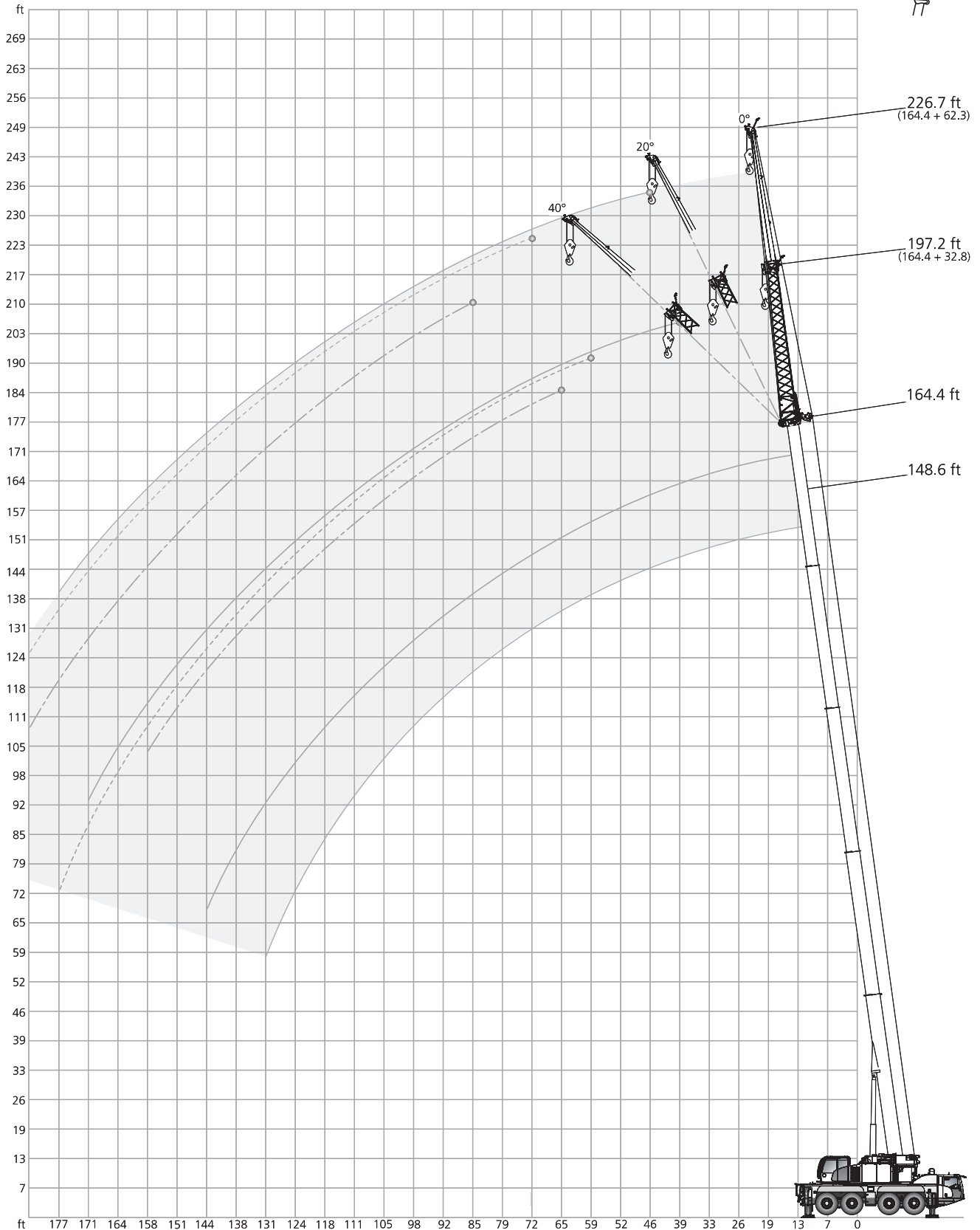
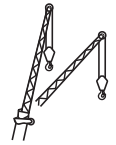

54,000 lb		26.6 ft x 23.6 ft						360°			ASME B30.5				
164.4 ft		32.8 ft			62.3 ft			148.6 ft		32.8 ft			62.3 ft		
ft		0°	20°	40°	0°	20°	40°	ft		0°	20°	40°	0°	20°	40°
1,000 lb															
40		14.6	-	-	8.4	-	-	36		17.9	-	-	-	-	-
48		14.6	-	-	8.4	-	-	40		17.9	-	-	10.1	-	-
56		14.6	14.6	-	8.4	-	-	48		17.9	-	-	10.1	-	-
64		14.6	14.6	13.4	8.4	-	-	56		17.9	17.9	-	10.1	-	-
72		14.6	13.9	12.6	8.4	-	-	64		17.9	17.9	16.2	10.1	-	-
80		14.5	13.1	12.0	8.4	8.4	-	72		17.9	17.6	15.9	10.1	9.9	-
88		13.9	12.2	11.3	8.4	8.4	7.5	80		16.7	16.8	15.6	10.1	9.7	8.1
96		12.1	11.5	10.7	8.4	8.1	7.1	88		14.7	15.3	15.1	10.1	9.4	7.8
104		10.2	10.9	10.2	8.4	7.6	6.9	96		12.3	13.3	13.7	10.0	9.1	7.6
112		8.5	9.4	9.8	7.9	7.0	6.4	104		11.0	11.3	11.7	9.7	8.9	7.5
120		7.2	7.8	8.3	7.4	6.7	6.1	112		9.4	9.8	9.8	9.0	8.6	7.3
128		5.9	6.6	6.9	6.2	6.3	5.8	120		7.9	8.5	8.9	7.6	8.3	7.3
136		4.9	5.4	5.8	5.1	6.0	5.6	128		6.8	7.3	7.6	6.8	7.6	7.2
144		4.0	4.4	4.7	4.2	5.1	5.3	136		5.8	6.2	6.4	6.0	6.4	6.9
152		3.2	3.6	3.6	3.4	4.3	4.9	144		4.7	5.1	5.3	4.9	5.5	6.0
160		2.5	2.8	-	2.6	3.5	3.9	152		3.9	4.3	-	4.1	5.0	5.0
168		-	-	-	-	2.8	3.1	160		3.3	3.5	-	3.4	4.2	4.5
176		-	-	-	-	2.1	2.3	168		-	-	-	2.8	3.3	3.1
								176		-	-	-	2.3	2.5	2.3
								184		-	-	-	-	2.0	-

95.5 ft		32.8 ft			62.3 ft		
ft		0°	20°	40°	0°	20°	40°
1,000 lb							
16		29.1	-	-	-	-	-
18		29.1	-	-	-	-	-
20		29.1	-	-	17.4	-	-
24		29.1	-	-	17.1	-	-
28		29.1	-	-	16.9	-	-
32		29.1	27.6	-	16.6	-	-
36		29.1	26.4	-	16.3	-	-
40		29.1	25.2	19.3	16.0	-	-
48		29.1	23.4	18.5	15.3	13.0	-
56		28.3	21.9	17.8	14.8	12.2	-
64		25.7	20.6	17.3	14.1	11.4	9.1
72		21.5	19.4	17.0	13.5	10.8	8.8
80		18.5	18.4	16.7	12.7	10.3	8.3
88		16.3	16.3	16.0	12.1	9.7	8.2
96		14.5	14.5	14.6	11.3	9.3	8.0
104		12.8	13.1	8.6	10.5	9.1	7.7
112		11.1	7.9	-	9.9	8.6	7.7
120		7.4	-	-	9.4	8.4	7.7
128		-	-	-	8.6	8.4	5.1
136		-	-	-	7.9	8.0	-
144		-	-	-	7.1	6.0	-

39.4 ft		32.8 ft			62.3 ft		
ft		0°	20°	40°	0°	20°	40°
1,000 lb							
10		29.1	-	-	21.6	-	-
12		29.1	-	-	21.5	-	-
14		29.1	-	-	21.4	-	-
16		29.1	29.1	-	21.1	-	-
18		29.1	29.1	-	20.7	-	-
20		29.1	28.9	-	20.4	-	-
24		29.1	26.8	-	19.6	-	-
28		29.1	24.7	20.3	18.8	-	-
32		29.1	23.0	19.3	17.9	14.5	-
36		27.2	21.6	18.5	16.9	13.7	-
40		24.8	20.3	17.8	15.9	12.9	-
48		21.2	18.4	16.9	13.8	11.6	-
56		18.5	17.2	-	12.2	10.6	9.3
64		-	-	-	11.0	9.6	8.7
72		-	-	-	9.9	9.1	8.2
80		-	-	-	9.2	8.6	-
88		-	-	-	8.6	-	-

42,500 lb		26.6 ft x 23.6 ft						360°			ASME B30.5				
164.4 ft		32.8 ft			62.3 ft			148.6 ft		32.8 ft			62.3 ft		
ft		0°	20°	40°	0°	20°	40°	ft		0°	20°	40°	0°	20°	40°
		1,000 lb								1,000 lb					
40		14.6	-	-	8.4	-	-	36		17.9	-	-	-	-	-
48		14.6	-	-	8.4	-	-	40		17.9	-	-	10.1	-	-
56		14.6	14.6	-	8.4	-	-	48		17.9	-	-	10.1	-	-
64		14.6	14.6	13.4	8.4	-	-	56		17.9	17.9	-	10.1	-	-
72		14.6	13.9	12.6	8.4	-	-	64		17.9	17.9	16.2	10.1	-	-
80		14.2	13.1	12.0	8.4	8.4	-	72		17.6	17.6	15.9	10.1	9.9	-
88		11.8	12.2	11.3	8.4	8.4	7.5	80		14.6	15.7	15.5	10.1	9.7	8.1
96		9.7	10.8	10.7	8.4	8.1	7.1	88		12.7	13.1	14.0	10.1	9.4	7.8
104		7.9	8.8	9.5	7.8	7.6	6.9	96		10.6	11.0	11.5	9.7	9.1	7.6
112		6.5	7.2	7.8	6.5	7.0	6.4	104		8.8	9.5	10.0	8.4	8.9	7.5
120		5.3	5.9	6.4	5.3	6.6	6.1	112		7.2	7.9	8.5	7.4	8.3	7.3
128		4.2	4.8	5.2	4.3	5.5	5.8	120		6.1	6.6	7.0	6.3	7.0	7.3
136		3.3	3.8	4.0	3.3	4.4	5.3	128		5.0	5.5	5.7	5.2	5.9	6.7
144		2.5	2.9	3.1	2.5	3.6	4.2	136		4.0	4.4	4.7	4.2	5.1	5.6
152		-	-	2.3	-	2.8	3.4	144		3.1	3.6	3.8	3.3	4.2	4.9
160		-	-	-	-	2.0	2.6	152		2.4	2.8	-	2.6	3.4	3.9
								160		-	2.0	-	2.0	2.6	3.1

95.5 ft		32.8 ft			62.3 ft		
ft		0°	20°	40°	0°	20°	40°
		1,000 lb					
16		29.1	-	-	-	-	-
18		29.1	-	-	-	-	-
20		29.1	-	-	17.4	-	-
24		29.1	-	-	17.1	-	-
28		29.1	-	-	16.9	-	-
32		29.1	27.6	-	16.6	-	-
36		29.1	26.4	-	16.3	-	-
40		29.1	25.2	19.3	16.0	-	-
48		29.1	23.4	18.5	15.3	13.0	-
56		27.2	21.9	17.8	14.8	12.2	-
64		22.9	20.6	17.3	14.1	11.4	9.1
72		19.5	19.2	17.0	13.5	10.8	8.8
80		16.8	17.0	16.4	12.7	10.3	8.3
88		14.4	14.7	15.1	12.1	9.7	8.2
96		12.3	12.8	13.0	11.3	9.3	8.0
104		10.9	11.0	8.6	10.4	9.1	7.7
112		9.6	7.9	-	9.6	8.6	7.7
120		7.4	-	-	8.3	8.4	7.7
128		-	-	-	7.5	7.8	5.1
136		-	-	-	6.8	7.0	-
144		-	-	-	6.0	4.6	-

39.4 ft		32.8 ft			62.3 ft		
ft		0°	20°	40°	0°	20°	40°
		1,000 lb					
10		29.1	-	-	21.6	-	-
12		29.1	-	-	21.5	-	-
14		29.1	-	-	21.4	-	-
16		29.1	29.1	-	21.1	-	-
18		29.1	29.1	-	20.7	-	-
20		29.1	28.9	-	20.4	-	-
24		29.1	26.8	-	19.6	-	-
28		29.1	24.7	20.3	18.8	-	-
32		29.1	23.0	19.3	17.9	14.5	-
36		27.2	21.6	18.5	16.9	13.7	-
40		24.8	20.3	17.8	15.9	12.9	-
48		21.2	18.4	16.9	13.8	11.6	-
56		18.5	17.2	-	12.2	10.6	9.3
64		-	-	-	11.0	9.6	8.7
72		-	-	-	9.9	9.1	8.2
80		-	-	-	9.2	8.6	-
88		-	-	-	8.6	-	-

19,000 lb		26.6 ft x 23.6 ft		360°			ASME B30.5			
164.4 ft		32.8 ft			62.3 ft			148.6 ft		
ft	0°	20°	40°	0°	20°	40°	ft	0°	20°	40°
	1,000 lb			1,000 lb				1,000 lb		
40	14.6	-	-	8.4	-	-	36	17.9	-	-
48	14.6	-	-	8.4	-	-	40	17.9	-	10.1
56	14.6	14.6	-	8.4	-	-	48	17.9	-	10.1
64	12.4	13.7	13.4	8.4	-	-	56	16.9	17.4	10.1
72	9.5	11.1	12.4	8.4	-	-	64	14.2	14.8	15.9
80	7.2	8.7	9.8	6.8	8.3	-	72	11.1	12.4	13.1
88	5.5	6.7	7.7	5.1	7.3	7.5	80	8.7	10.0	11.1
96	4.2	5.1	6.0	3.7	5.7	7.1	88	7.0	8.0	8.8
104	2.8	3.7	4.6	2.6	4.4	5.9	96	5.3	6.2	7.0
112	-	2.6	3.2	-	3.0	4.6	104	4.1	4.8	5.5
120	-	-	2.2	-	2.2	3.5	112	2.8	3.7	4.1
128	-	-	-	-	-	2.4	120	-	2.5	2.9
							128	-	-	2.0
							136	-	-	-

95.5 ft		32.8 ft			62.3 ft		
ft	0°	20°	40°	0°	20°	40°	
	1,000 lb			1,000 lb			
16	29.1	-	-	-	-	-	
18	29.1	-	-	-	-	-	
20	29.1	-	-	17.4	-	-	
24	29.1	-	-	17.1	-	-	
28	29.1	-	-	16.9	-	-	
32	29.1	27.6	-	16.6	-	-	
36	29.1	26.4	-	16.3	-	-	
40	29.0	25.2	19.3	16.0	-	-	
48	26.4	23.4	18.5	15.3	13.0	-	
56	20.9	21.0	17.8	14.8	12.2	-	
64	17.1	17.9	17.3	14.1	11.4	9.1	
72	14.0	14.8	15.5	13.2	10.8	8.8	
80	11.6	12.2	12.7	11.8	10.3	8.3	
88	9.5	10.2	10.5	9.9	9.7	8.2	
96	7.8	8.3	8.6	8.2	9.2	8.0	
104	6.3	6.8	7.0	7.0	7.9	7.7	
112	5.2	5.5	-	5.7	6.6	7.2	
120	4.2	-	-	4.7	5.5	5.9	
128	-	-	-	3.9	4.4	4.7	
136	-	-	-	3.2	3.5	-	
144	-	-	-	2.7	2.7	-	

39.4 ft		32.8 ft			62.3 ft		
ft	0°	20°	40°	0°	20°	40°	
	1,000 lb			1,000 lb			
10	29.1	-	-	21.6	-	-	
12	29.1	-	-	21.5	-	-	
14	29.1	-	-	21.4	-	-	
16	29.1	29.1	-	21.1	-	-	
18	29.1	29.1	-	20.7	-	-	
20	29.1	28.9	-	20.4	-	-	
24	29.1	26.8	-	19.6	-	-	
28	29.1	24.7	20.3	18.8	-	-	
32	29.1	23.0	19.3	17.9	14.5	-	
36	27.2	21.6	18.5	16.9	13.7	-	
40	24.8	20.3	17.8	15.9	12.9	-	
48	21.2	18.4	16.9	13.8	11.6	-	
56	18.5	17.2	-	12.2	10.6	9.3	
64	-	-	-	11.0	9.6	8.7	
72	-	-	-	9.9	9.1	8.2	
80	-	-	-	9.2	8.6	-	
88	-	-	-	8.6	-	-	

13,400 lb		26.6 ft x 23.6 ft						360°			ASME B30.5				
164.4 ft		32.8 ft			62.3 ft			148.6 ft		32.8 ft			62.3 ft		
ft		0°	20°	40°	0°	20°	40°	ft		0°	20°	40°	0°	20°	40°
1,000 lb															
40		14.6	-	-	8.4	-	-	36		17.9	-	-	-	-	-
48		14.6	-	-	8.4	-	-	40		17.9	-	-	10.1	-	-
56		13.4	14.4	-	8.4	-	-	48		17.5	17.3	-	10.1	-	-
64		10.4	12.2	13.3	8.4	-	-	56		15.5	16.2	-	10.1	-	-
72		7.6	9.1	10.6	7.1	-	-	64		12.0	13.4	14.4	9.9	-	-
80		5.5	7.0	8.1	5.0	7.6	-	72		9.1	10.4	11.7	8.6	9.9	-
88		4.0	5.2	6.2	3.5	5.8	7.4	80		7.0	8.3	9.4	6.6	8.7	8.1
96		2.6	3.7	4.6	2.3	4.2	6.0	88		5.3	6.4	7.3	5.0	7.0	7.8
104		-	2.6	3.3	-	3.0	4.6	96		3.9	4.8	5.7	3.6	5.5	6.9
112		-	-	-	-	-	3.5	104		2.8	3.7	4.4	2.6	4.1	5.5
120		-	-	-	-	-	2.4	112		-	2.6	3.0	-	3.0	4.3
								120		-	-	-	-	2.2	3.3
								128		-	-	-	-	-	2.3

95.5 ft		32.8 ft			62.3 ft		
ft		0°	20°	40°	0°	20°	40°
1,000 lb							
16		29.1	-	-	-	-	-
18		29.1	-	-	-	-	-
20		29.1	-	-	17.4	-	-
24		29.1	-	-	17.1	-	-
28		29.1	-	-	16.9	-	-
32		29.1	27.6	-	16.6	-	-
36		29.1	26.4	-	16.3	-	-
40		28.8	25.2	19.3	16.0	-	-
48		24.4	23.0	18.5	15.3	13.0	-
56		19.4	19.8	17.8	14.8	12.2	-
64		15.3	16.4	16.6	14.0	11.4	9.1
72		12.2	13.1	13.7	12.6	10.8	8.8
80		10.0	10.7	11.1	10.5	10.2	8.3
88		8.1	8.7	9.2	8.6	9.4	8.2
96		6.6	7.1	7.4	7.0	8.2	7.9
104		5.2	5.7	5.9	5.7	6.8	7.3
112		4.1	4.6	-	4.6	5.5	6.1
120		3.3	-	-	3.8	4.4	5.0
128		-	-	-	3.0	3.5	4.0
136		-	-	-	2.3	2.6	-
144		-	-	-	1.8	2.0	-

39.4 ft		32.8 ft			62.3 ft		
ft		0°	20°	40°	0°	20°	40°
1,000 lb							
10		29.1	-	-	21.6	-	-
12		29.1	-	-	21.5	-	-
14		29.1	-	-	21.4	-	-
16		29.1	29.1	-	21.1	-	-
18		29.1	29.1	-	20.7	-	-
20		29.1	28.9	-	20.4	-	-
24		29.1	26.8	-	19.6	-	-
28		29.1	24.7	20.3	18.8	-	-
32		29.1	23.0	19.3	17.9	14.5	-
36		27.2	21.6	18.5	16.9	13.7	-
40		24.8	20.3	17.8	15.9	12.9	-
48		21.2	18.4	16.9	13.8	11.6	-
56		18.5	17.2	-	12.2	10.6	9.3
64		-	-	-	11.0	9.6	8.7
72		-	-	-	9.9	9.1	8.2
80		-	-	-	9.2	8.6	-
88		-	-	-	8.6	-	-

9,500 lb		26.6 ft x 23.6 ft						360°			ASME B30.5				
164.4 ft		32.8 ft			62.3 ft			148.6 ft		32.8 ft			62.3 ft		
ft		0°	20°	40°	0°	20°	40°	ft		0°	20°	40°	0°	20°	40°
		1,000 lb								1,000 lb					
40		14.6	-	-	8.4	-	-	36		17,9	-	-	-	-	-
48		14.2	-	-	8.4	-	-	40		17,9	-	-	10,1	-	-
56		11.8	13.5	-	8.4	-	-	48		16,9	17,3	-	10,1	-	-
64		8.5	10.4	12.1	7.5	-	-	56		13,6	15,2	14,3	10,1	-	-
72		6.2	7.8	9.1	5.6	-	-	64		10,3	12,0	13,1	9,3	-	-
80		4.4	5.7	6.8	3.8	6.3	-	72		7,6	9,1	10,4	7,1	9,7	-
88		2.9	4.0	5.0	2.4	4.6	6.6	80		5,7	7,0	8,0	5,3	7,6	8,1
96		-	2.6	3.5	-	3.3	5.0	88		4,2	5,2	6,1	3,7	5,8	7,4
104		-	-	2.3	-	2.1	3.7	96		2,8	3,9	4,6	2,5	4,4	6,0
112		-	-	-	-	-	2.4	104		1,9	2,6	3,3	-	3,2	4,6
								112		-	-	-	-	-	3,5
								120		-	-	-	-	-	2,5

95.5 ft		32.8 ft			62.3 ft		
ft		0°	20°	40°	0°	20°	40°
		1,000 lb					
16		29.1	-	-	-	-	-
18		29.1	-	-	-	-	-
20		29.1	-	-	17.4	-	-
24		29.1	-	-	17.1	-	-
28		29.1	-	-	16.9	-	-
32		29.1	27.6	-	16.6	-	-
36		29.1	26.4	-	16.3	-	-
40		28.6	25.2	19.3	16.0	-	-
48		23.1	22.4	18.5	15.3	13.0	-
56		17.7	18.9	17.7	14.6	12.2	-
64		13.9	14.9	15.6	13.4	11.4	9.1
72		11.1	12.0	12.4	11.5	10.8	8.8
80		8.7	9.6	10.1	9.4	10.0	8.3
88		7.0	7.6	8.2	7.6	8.8	8.1
96		5.5	6.1	6.4	6.1	7.2	7.8
104		4.3	4.8	5.0	4.8	5.9	6.6
112		3.5	3.7	-	3.9	4.8	5.4
120		2.5	-	-	3.0	3.7	4.2
128		-	-	-	2.3	2.8	3.2
136		-	-	-	-	2.1	-

39.4 ft		32.8 ft			62.3 ft		
ft		0°	20°	40°	0°	20°	40°
		1,000 lb					
10		29.1	-	-	21.6	-	-
12		29.1	-	-	21.5	-	-
14		29.1	-	-	21.4	-	-
16		29.1	29.1	-	21.1	-	-
18		29.1	29.1	-	20.7	-	-
20		29.1	28.9	-	20.4	-	-
24		29.1	26.8	-	19.6	-	-
28		29.1	24.7	20.3	18.8	-	-
32		29.1	23.0	19.3	17.9	14.5	-
36		27.2	21.6	18.5	16.9	13.7	-
40		24.8	20.3	17.8	15.9	12.9	-
48		21.2	18.4	16.9	13.8	11.6	-
56		17.5	16.9	-	12.2	10.6	9.3
64		-	-	-	11.0	9.6	8.7
72		-	-	-	9.9	9.1	8.2
80		-	-	-	9.2	8.6	-
88		-	-	-	8.5	-	-

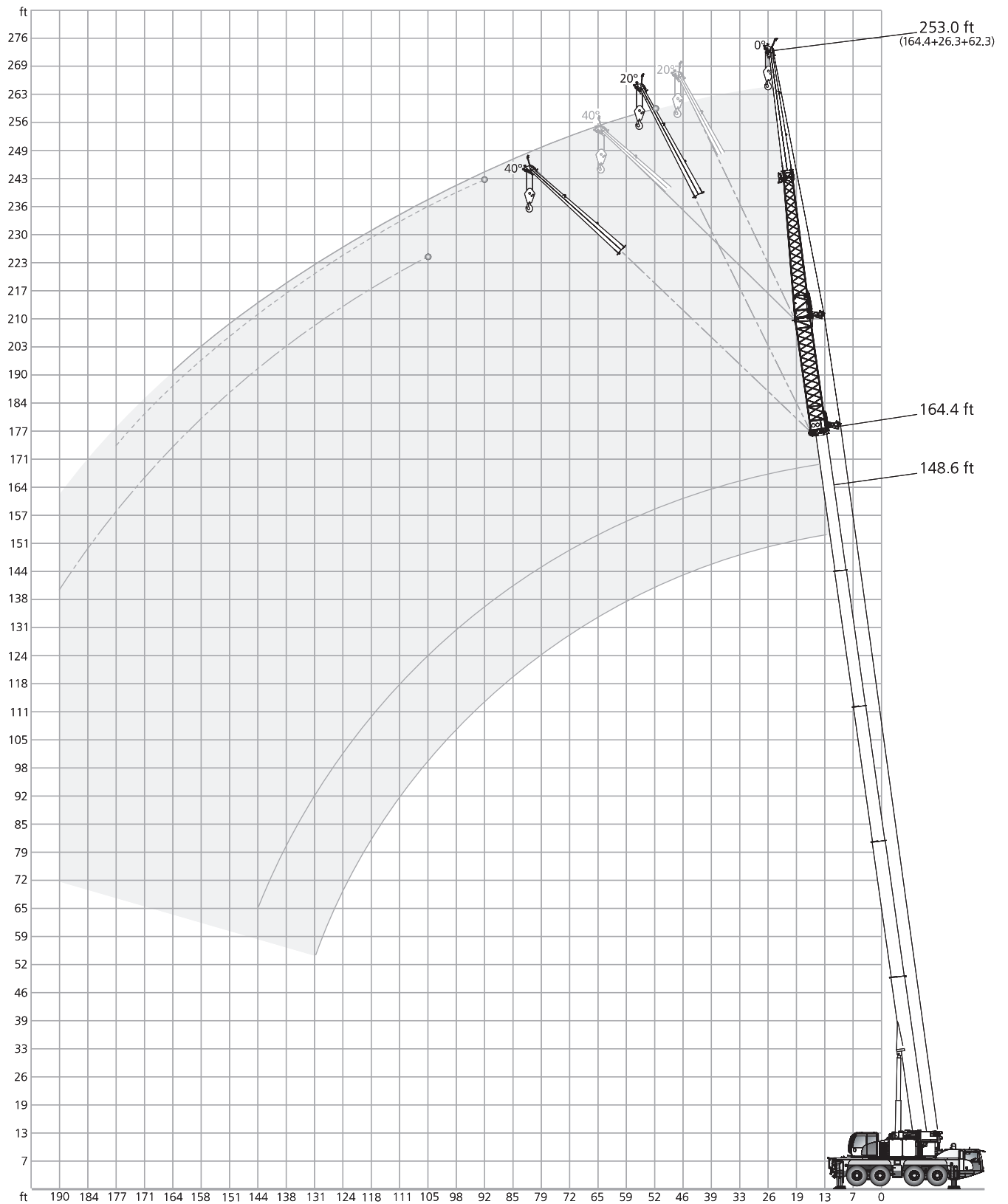
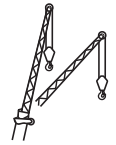



54,000 lb		26.6 ft x 23.6 ft					360°		ASME B30.5	
164.4 ft		26.3 ft					148.6 ft		26.3 ft	
		0°	0°	0°	20°	40°			0°	0°
		62.3 ft							62.3 ft	
		0°	20°	40°	0°	0°*			0°	0°
ft		1,000 lb					ft		1,000 lb	
48	9.3	-	-	-	-	-	40	11.7	-	-
56	9.3	-	-	-	-	-	48	11.7	-	-
64	9.3	9.3	-	-	-	-	56	11.7	-	-
72	9.3	9.3	-	-	-	-	64	11.7	11.7	-
80	9.3	9.3	9.1	8.7	-	-	72	11.7	11.7	11.3
88	9.3	9.0	8.4	8.1	7.1	-	80	11.7	11.4	10.9
96	9.0	8.2	7.9	7.4	6.7	-	88	11.5	10.9	10.5
104	8.3	7.6	7.3	6.9	6.2	-	96	11.0	10.5	10.2
112	7.6	7.0	6.8	6.6	5.9	-	104	9.5	10.0	9.8
120	6.3	6.5	6.3	6.1	5.7	-	112	7.9	8.7	9.4
128	5.1	5.7	5.9	5.7	5.4	-	120	6.7	7.2	7.8
136	4.0	4.7	5.1	5.0	5.1	-	128	5.8	5.9	6.5
144	2.9	3.6	4.0	4.0	4.9	-	136	4.8	5.3	5.4
152	2.1	2.8	3.0	3.0	3.8	-	144	3.8	4.2	4.7
160	-	-	2.2	2.2	2.8	-	152	3.0	3.4	3.6
							160	2.3	2.6	2.8

95.5 ft		26.3 ft				
		0°	0°	0°	20°	40°
		62.3 ft				
		0°	20°	40°	0°	0°
ft		1,000 lb				
24	25.4	-	-	-	-	-
28	24.6	-	-	-	-	-
32	23.6	-	-	-	-	-
36	22.5	19.1	-	-	-	-
40	21.4	18.2	-	-	-	-
48	19.4	16.6	14.7	14.3	-	-
56	17.7	15.3	13.8	13.2	-	-
64	16.0	14.1	12.9	12.3	10.0	-
72	14.6	13.0	12.1	11.5	9.7	-
80	13.5	12.2	11.4	10.9	9.2	-
88	12.5	11.4	10.8	10.3	8.9	-
96	11.7	10.7	10.3	9.9	8.7	-
104	10.9	10.2	10.0	9.3	8.4	-
112	9.9	9.7	9.7	8.8	8.4	-
120	8.8	9.0	5.0	8.5	8.2	-
128	7.9	7.9	-	7.9	4.5	-
136	6.9	7.1	-	7.2	-	-
144	5.8	4.0	-	4.0	-	-

39.4 ft		26.3 ft				
		0°	0°	0°	20°	40°
		62.3 ft				
		0°	20°	40°	0°	0°
ft		1,000 lb				
10	29.1	-	-	-	-	-
12	29.1	-	-	-	-	-
14	29.1	-	-	-	-	-
16	29.1	-	-	-	-	-
18	29.1	-	-	-	-	-
20	28.9	24.3	-	-	-	-
24	26.0	22.2	-	-	-	-
28	23.4	20.2	-	-	-	-
32	21.2	18.6	16.8	16.4	-	-
36	19.3	17.3	15.8	15.3	-	-
40	17.7	16.1	14.9	14.4	-	-
48	15.3	14.1	13.3	12.8	11.0	-
56	13.4	12.4	11.9	11.4	10.0	-
64	12.0	11.2	11.0	10.5	9.4	-
72	10.6	10.2	10.2	9.5	8.8	-
80	9.6	9.4	-	9.0	-	-

 * 161.1 ft

42,500 lb		26.3 ft x 23.6 ft					360°		ASME B30.5		
											
		26.3 ft							26.3 ft		
		0° 0° 0° 20° 40°							0° 0° 0° 20° 40°		
		62.3 ft							62.3 ft		
		0° 20° 40° 0° 0°*							0° 20° 40° 0° 0°		
ft	1,000 lb					ft	1,000 lb				
48	9.3	-	-	-	-	40	11.7	-	-	-	-
56	9.3	-	-	-	-	48	11.7	-	-	-	-
64	9.3	9.3	-	-	-	56	11.7	-	-	-	-
72	9.3	9.3	-	-	-	64	11.7	11.7	-	-	-
80	9.3	9.3	9.1	8.7	-	72	11.7	11.7	11.3	10.8	-
88	9.3	9.0	8.4	8.1	7.1	80	11.6	11.4	10.9	10.3	8.8
96	8.3	8.2	7.9	7.4	6.7	88	10.7	10.9	10.5	10.0	8.5
104	6.6	7.6	7.3	6.9	6.2	96	8.9	10.0	10.2	9.6	8.2
112	5.2	6.1	6.8	6.6	5.9	104	7.8	8.2	9.0	8.7	8.2
120	4.2	5.0	5.6	5.6	5.7	112	6.3	6.8	7.4	7.2	7.9
128	3.1	4.0	4.4	4.4	5.2	120	5.2	5.9	6.0	5.9	6.9
136	2.2	2.9	3.3	3.3	4.2	128	4.0	4.6	5.2	5.1	5.4
144	-	2.0	2.5	2.5	3.1	136	3.0	3.7	4.0	4.0	4.6
152	-	-	-	-	2.3	144	2.2	2.7	3.1	3.1	3.6
						152	-	-	2.1	2.1	2.7

						
		26.3 ft				
		0° 0° 0° 20° 40°				
		62.3 ft				
		0° 20° 40° 0° 0°				
ft	1,000 lb					
24	25.4	-	-	-	-	
28	24.6	-	-	-	-	
32	23.6	-	-	-	-	
36	22.5	19.1	-	-	-	
40	21.4	18.2	-	-	-	
48	19.4	16.6	14.7	14.3	-	
56	17.7	15.3	13.8	13.2	-	
64	16.0	14.1	12.9	12.3	10.0	
72	14.6	13.0	12.1	11.5	9.7	
80	13.5	12.2	11.4	10.9	9.2	
88	12.4	11.4	10.8	10.3	8.9	
96	11.2	10.7	10.3	9.9	8.7	
104	10.1	10.0	10.0	9.3	8.4	
112	8.5	9.0	9.0	8.8	8.3	
120	7.4	7.7	5.0	7.9	8.0	
128	6.6	6.7	-	6.7	4.5	
136	5.5	5.8	-	5.9	-	
144	4.9	4.0	-	4.0	-	

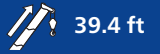
						
		26.3 ft				
		0° 0° 0° 20° 40°				
		62.3 ft				
		0° 20° 40° 0° 0°				
ft	1,000 lb					
10	29.1	-	-	-	-	
12	29.1	-	-	-	-	
14	29.1	-	-	-	-	
16	29.1	-	-	-	-	
18	29.1	-	-	-	-	
20	28.9	24.3	-	-	-	
24	26.0	22.2	-	-	-	
28	23.4	20.2	-	-	-	
32	21.2	18.6	16.8	16.4	-	
36	19.3	17.3	15.8	15.3	-	
40	17.7	16.1	14.9	14.4	-	
48	15.3	14.1	13.3	12.8	11.0	
56	13.4	12.4	11.9	11.4	10.0	
64	12.0	11.2	11.0	10.5	9.4	
72	10.6	10.2	10.2	9.5	8.8	
80	9.6	9.4	-	9.0	-	

 * 161.1 ft

19,000 lb  **26.6 ft x 23.6 ft** **360°** **ASME B30.5**

164.4 ft 

ft	26.3 ft				
	0°	0°	0°	20°	40°
	62.3 ft				
	0°	20°	40°	0°	0°*
1,000 lb					
48	9.3	-	-	-	-
56	9.3	-	-	-	-
64	9.3	9.3	-	-	-
72	7.8	9.3	-	-	-
80	5.7	7.2	8.5	8.3	-
88	3.9	5.2	6.4	6.2	7.1
96	2.5	3.7	4.7	4.6	6.3
104	-	2.4	3.3	3.3	5.0
112	-	-	-	-	3.7
120	-	-	-	-	2.4

148.6 ft 

ft	26.3 ft				
	0°	0°	0°	20°	40°
	62.3 ft				
	0°	20°	40°	0°	0°
1,000 lb					
40	11.7	-	-	-	-
48	11.7	-	-	-	-
56	11.7	-	-	-	-
64	11.5	11.7	-	-	-
72	9.3	10.4	11.3	10.8	-
80	7.2	8.5	9.1	8.9	8.8
88	5.4	6.6	7.7	7.5	8.2
96	3.9	5.0	6.0	5.8	6.9
104	2.6	3.7	4.4	4.4	5.6
112	-	2.6	3.2	3.0	4.3
120	-	-	2.2	2.2	3.3
128	-	-	-	-	2.2

95.5 ft 

ft	26.3 ft				
	0°	0°	0°	20°	40°
	62.3 ft				
	0°	20°	40°	0°	0°
1,000 lb					
24	25.4	-	-	-	-
28	24.6	-	-	-	-
32	23.6	-	-	-	-
36	22.5	19.1	-	-	-
40	21.4	18.2	-	-	-
48	19.4	16.6	14.7	14.3	-
56	17.7	15.3	13.8	13.2	-
64	15.5	14.1	12.9	12.3	10.0
72	13.7	13.0	12.1	11.5	9.7
80	11.1	11.6	11.3	10.7	9.2
88	9.0	9.9	10.1	9.8	8.9
96	7.2	8.0	8.5	8.4	8.5
104	5.9	6.4	6.8	6.8	7.4
112	4.6	5.2	5.4	5.5	6.1
120	3.6	4.0	4.2	4.4	4.8
128	2.8	3.1	-	3.3	3.5
136	2.1	2.2	-	2.4	-
144	-	-	-	1.6	-

39.4 ft 

ft	26.3 ft				
	0°	0°	0°	20°	40°
	62.3 ft				
	0°	20°	40°	0°	0°
1,000 lb					
10	29.1	-	-	-	-
12	29.1	-	-	-	-
14	29.1	-	-	-	-
16	29.1	-	-	-	-
18	29.1	-	-	-	-
20	28.9	24.3	-	-	-
24	26.0	22.2	-	-	-
28	23.4	20.2	-	-	-
32	21.2	18.6	16.8	16.4	-
36	19.3	17.3	15.8	15.3	-
40	17.7	16.1	14.9	14.4	-
48	15.3	14.1	13.3	12.8	11.0
56	13.4	12.4	11.9	11.4	10.0
64	12.0	11.2	11.0	10.5	9.4
72	10.6	10.2	10.2	9.5	8.8
80	9.6	9.4	-	9.0	-



 ***161.1 ft**

13,400 lb		26.3 ft x 23.6 ft					360°		ASME B30.5		
164.4 ft							148.6 ft				
		26.3 ft							26.3 ft		
		0° 0° 0° 20° 40°							0° 0° 0° 20° 40°		
		62.3 ft							62.3 ft		
		0° 20° 40° 0° 0°*							0° 20° 40° 0° 0°		
ft	1,000 lb					ft	1,000 lb				
48	9.3	-	-	-	-	40	11.7	-	-	-	
56	9.3	-	-	-	-	48	11.7	-	-	-	
64	8.1	9.3	-	-	-	56	11.5	11.5	-	-	
72	5.8	7.5	-	-	-	64	10.0	11.3	-	-	
80	3.9	5.4	6.8	6.5	-	72	7.5	9.1	10.0	9.7	
88	2.4	3.6	5.0	4.7	6.7	80	5.4	6.9	8.1	7.9	
96	-	2.3	3.4	3.3	5.1	88	3.7	5.0	6.2	6.0	
104	-	-	2.1	1.9	3.7	96	2.5	3.5	4.5	4.4	
112	-	-	-	-	2.4	104	-	2.3	3.2	3.0	
						112	-	-	-	3.2	

95.5 ft						
		26.3 ft				
		0° 0° 0° 20° 40°				
		62.3 ft				
		0° 20° 40° 0° 0°				
ft	1,000 lb					
24	25.4	-	-	-	-	
28	24.6	-	-	-	-	
32	23.6	-	-	-	-	
36	22.5	19.1	-	-	-	
40	21.4	18.2	-	-	-	
48	19.4	16.6	14.7	14.3	-	
56	17.2	15.3	13.8	13.2	-	
64	14.8	14.1	12.9	12.3	10.0	
72	12.0	12.6	12.1	11.5	9.7	
80	9.6	10.5	10.9	10.5	9.2	
88	7.6	8.4	9.1	9.0	8.8	
96	6.0	6.7	7.2	7.1	7.9	
104	4.6	5.2	5.7	5.7	6.4	
112	3.5	4.1	4.3	4.3	5.0	
120	2.7	3.1	3.3	3.3	3.7	
128	1.9	2.1	-	2.3	2.6	

39.4 ft						
		26.3 ft				
		0° 0° 0° 20° 40°				
		62.3 ft				
		0° 20° 40° 0° 0°				
ft	1,000 lb					
10	29.1	-	-	-	-	
12	29.1	-	-	-	-	
14	29.1	-	-	-	-	
16	29.1	-	-	-	-	
18	29.1	-	-	-	-	
20	28.9	24.3	-	-	-	
24	26.0	22.2	-	-	-	
28	23.4	20.2	-	-	-	
32	21.2	18.6	16.8	16.4	-	
36	19.3	17.3	15.8	15.3	-	
40	17.7	16.1	14.9	14.4	-	
48	15.3	14.1	13.3	12.8	11.0	
56	13.4	12.4	11.9	11.4	10.0	
64	12.0	11.2	11.0	10.5	9.4	
72	10.6	10.2	10.2	9.5	8.8	
80	9.6	9.4	-	9.0	-	

 *161.1 ft

9,500 lb		26.6 ft x 23.6 ft					360°		ASME B30.5				
 164.4 ft							 148.6 ft						
		26.3 ft							26.3 ft				
		0°	0°	0°	20°	40°			0°	0°	0°	20°	40°
		62.3 ft							62.3 ft				
		0°	20°	40°	0°	0°*			0°	20°	40°	0°	0°
ft		1,000 lb					ft		1,000 lb				
48	9.3	-	-	-	-	-	40	11.7	-	-	-	-	-
56	8.9	-	-	-	-	-	48	11.7	-	-	-	-	-
64	6.8	8.4	-	-	-	-	56	10.9	11.5	-	-	-	-
72	4.5	6.2	-	-	-	-	64	8.5	10.1	-	-	-	-
80	2.6	4.2	5.4	5.3	-	-	72	6.0	7.6	9.1	8.8	-	-
88	-	2.6	3.6	3.6	5.8	-	80	4.2	5.7	6.8	6.5	8.3	-
96	-	-	2.3	2.2	4.2	-	88	2.6	3.9	5.0	4.7	6.6	-
104	-	-	-	-	2.8	-	96	-	2.5	3.5	3.3	4.9	-
							104	-	-	2.2	2.1	3.5	-

 95.5 ft													
		26.3 ft							26.3 ft				
		0°	0°	0°	20°	40°			0°	0°	0°	20°	40°
		62.3 ft							62.3 ft				
		0°	20°	40°	0°	0°			0°	20°	40°	0°	0°
ft		1,000 lb					ft		1,000 lb				
24	25.4	-	-	-	-	-	10	29.1	-	-	-	-	-
28	24.6	-	-	-	-	-	12	29.1	-	-	-	-	-
32	23.6	-	-	-	-	-	14	29.1	-	-	-	-	-
36	22.5	19.1	-	-	-	-	16	29.1	-	-	-	-	-
40	21.4	18.2	-	-	-	-	18	29.1	-	-	-	-	-
48	18.9	16.6	14.7	14.3	-	-	20	28.9	24.3	-	-	-	-
56	16.4	15.3	13.8	13.2	-	-	24	26.0	22.2	-	-	-	-
64	13.7	13.7	12.9	12.3	10.0	-	28	23.4	20.2	-	-	-	-
72	10.6	11.7	11.9	11.5	9.7	-	32	21.2	18.6	16.8	16.4	-	-
80	8.3	9.4	10.2	9.8	9.2	-	36	19.3	17.3	15.8	15.3	-	-
88	6.5	7.4	8.0	7.8	8.5	-	40	17.7	16.1	14.9	14.4	-	-
96	5.0	5.8	6.2	6.2	7.1	-	48	15.3	14.1	13.3	12.8	11.0	-
104	3.7	4.4	4.8	4.8	5.5	-	56	13.4	12.4	11.9	11.4	10.0	-
112	2.8	3.2	3.5	3.5	4.1	-	64	12.0	11.2	11.0	10.5	9.4	-
120	-	2.2	2.5	2.6	3.1	-	72	10.6	10.2	10.2	9.5	8.8	-
128	-	-	-	-	2.0	-	80	9.4	9.3	-	9.0	-	-

 39.4 ft													
		26.3 ft							26.3 ft				
		0°	0°	0°	20°	40°			0°	0°	0°	20°	40°
		62.3 ft							62.3 ft				
		0°	20°	40°	0°	0°			0°	20°	40°	0°	0°
ft		1,000 lb					ft		1,000 lb				
10	29.1	-	-	-	-	-	10	29.1	-	-	-	-	-
12	29.1	-	-	-	-	-	12	29.1	-	-	-	-	-
14	29.1	-	-	-	-	-	14	29.1	-	-	-	-	-
16	29.1	-	-	-	-	-	16	29.1	-	-	-	-	-
18	29.1	-	-	-	-	-	18	29.1	-	-	-	-	-
20	28.9	24.3	-	-	-	-	20	28.9	24.3	-	-	-	-
24	26.0	22.2	-	-	-	-	24	26.0	22.2	-	-	-	-
28	23.4	20.2	-	-	-	-	28	23.4	20.2	-	-	-	-
32	21.2	18.6	16.8	16.4	-	-	32	21.2	18.6	16.8	16.4	-	-
36	19.3	17.3	15.8	15.3	-	-	36	19.3	17.3	15.8	15.3	-	-
40	17.7	16.1	14.9	14.4	-	-	40	17.7	16.1	14.9	14.4	-	-
48	15.3	14.1	13.3	12.8	11.0	-	48	15.3	14.1	13.3	12.8	11.0	-
56	13.4	12.4	11.9	11.4	10.0	-	56	13.4	12.4	11.9	11.4	10.0	-
64	12.0	11.2	11.0	10.5	9.4	-	64	12.0	11.2	11.0	10.5	9.4	-
72	10.6	10.2	10.2	9.5	8.8	-	72	10.6	10.2	10.2	9.5	8.8	-
80	9.4	9.3	-	9.0	-	-	80	9.4	9.3	-	9.0	-	-







 *161.1 ft







54,000 lb		26.3 ft x 23.6 ft					360°		ASME B30.5			
164.4 ft		26.3 ft					148.6 ft		26.3 ft			
		0°	0°	0°	20°	40°			0°	0°	20°	40°
		32.8 ft							32.8 ft			
		0°	20°*	40°*	0°	0°			0°	20°	40°	0°**
ft		1,000 lb					ft		1,000 lb			
56	5.5	-	-	-	-	-	48	6.8	-	-	-	-
64	5.5	-	-	-	-	-	56	6.8	-	-	-	-
72	5.5	-	-	-	-	-	64	6.8	-	-	-	-
80	5.5	5.7	-	-	-	-	72	6.8	-	-	-	-
88	5.5	5.7	-	-	-	-	80	6.8	6.8	-	-	-
96	5.5	5.7	-	-	-	-	88	6.8	6.7	-	6.0	-
104	5.5	5.5	5.1	-	-	-	96	6.8	6.5	6.0	5.8	-
112	5.5	5.1	4.8	-	-	-	104	6.6	6.2	5.8	5.5	4.9
120	5.2	4.8	4.5	-	-	-	112	6.4	5.9	5.7	5.5	4.8
128	4.7	4.4	4.1	-	-	-	120	6.0	5.7	5.4	5.2	4.6
136	3.8	4.0	3.8	-	-	-	128	5.3	5.5	5.3	5.0	4.4
144	2.9	3.8	3.5	-	-	-	136	4.4	5.4	5.1	4.9	4.2
152	2.1	3.4	3.3	-	-	-	144	3.8	4.7	4.9	4.6	4.2
160	-	2.6	3.2	-	-	-	152	3.2	3.6	4.5	3.9	4.2
168	-	-	2.7	-	-	-	160	2.4	3.0	3.5	3.1	3.9
176	-	-	1.9	-	-	-	168	-	2.5	2.7	-	2.9
							176	-	1.9	2.3	-	2.1

95.5 ft		26.3 ft				
		0°	0°	0°	20°	40°
		32.8 ft				
		0°	20°	40°	0°	0°
ft		1,000 lb				
28	13.4	-	-	-	-	-
32	13.4	-	-	-	-	-
36	13.2	-	-	-	-	-
40	12.9	-	-	-	-	-
48	12.1	-	-	-	-	-
56	11.3	10.0	-	-	-	-
64	10.5	9.2	-	8.3	-	-
72	9.9	8.6	7.7	7.7	-	-
80	9.1	8.1	7.2	7.2	-	-
88	8.4	7.5	6.9	6.7	5.6	-
96	7.9	7.0	6.5	6.3	5.2	-
104	7.3	6.6	6.2	6.0	4.9	-
112	6.8	6.2	5.9	5.7	4.8	-
120	6.3	5.9	5.7	5.2	4.6	-
128	5.9	5.6	5.4	5.0	4.4	-
136	5.6	5.2	5.1	4.7	4.4	-
144	5.1	5.1	5.1	4.6	4.4	-
152	4.8	4.8	2.6	4.4	-	-
160	4.5	4.6	-	4.4	-	-

39.4 ft		26.3 ft				
		0°	0°	0°	20°	40°
		32.8 ft				
		0°	20°	40°	0°	0°
ft		1,000 lb				
14	17.9	-	-	-	-	-
16	17.9	-	-	-	-	-
18	17.8	-	-	-	-	-
20	17.6	-	-	-	-	-
24	16.8	-	-	-	-	-
28	16.0	-	-	-	-	-
32	15.2	-	-	-	-	-
36	14.2	-	-	-	-	-
40	13.3	12.0	-	-	-	-
48	11.7	10.5	-	9.6	-	-
56	10.2	9.4	8.7	8.6	-	-
64	9.0	8.4	7.9	7.7	-	-
72	8.2	7.5	7.1	7.1	-	-
80	7.4	6.7	6.5	6.3	5.6	-
88	6.6	6.2	6.1	5.8	5.2	-
96	5.9	5.7	5.7	5.2	4.9	-
104	5.4	5.3	-	4.9	4.7	-
112	4.8	-	-	-	-	-

 *161.1 ft **137.5 ft

42,500 lb		26.6 ft x 23.6 ft		360°		ASME B30.5	
 164.4 ft		 148.6 ft					
 		 					
		26.3 ft		26.3 ft			
		0° 0° 0° 20° 40°		0° 0° 0° 20° 40°			
		32.8 ft		32.8 ft			
		0° 20°* 40°*		0° 0° 0°**			
ft		1,000 lb		ft			
1,000 lb		1,000 lb		1,000 lb			
56	5.5	-	-	-	-	48	6.8
64	5.5	-	-	-	-	56	6.8
72	5.5	-	-	-	-	64	6.8
80	5.5	5.7	-	-	-	72	6.8
88	5.5	5.7	-	-	-	80	6.8
96	5.5	5.7	-	-	-	88	6.8
104	5.5	5.5	5.1	-	-	96	6.8
112	4.8	5.1	4.8	-	-	104	6.6
120	3.7	4.8	4.5	-	-	112	5.5
128	2.8	4.3	4.1	-	-	120	4.9
136	1.9	3.5	3.8	-	-	128	4.0
144	-	2.7	3.5	-	-	136	3.0
152	-	-	2.8	-	-	144	2.4
160	-	-	2.0	-	-	152	-
						160	-

 95.5 ft		 39.4 ft					
 		 					
		26.3 ft		26.3 ft			
		0° 0° 0° 20° 40°		0° 0° 0° 20° 40°			
		32.8 ft		32.8 ft			
		0° 20° 40°		0° 0°			
ft		1,000 lb		ft			
1,000 lb		1,000 lb		1,000 lb			
28	13.4	-	-	-	-	14	17.9
32	13.4	-	-	-	-	16	17.9
36	13.2	-	-	-	-	18	17.8
40	12.9	-	-	-	-	20	17.6
48	12.1	-	-	-	-	24	16.8
56	11.3	10.0	-	-	-	28	16.0
64	10.5	9.2	-	8.3	-	32	15.2
72	9.9	8.6	7.7	7.7	-	36	14.2
80	9.1	8.1	7.2	7.2	-	40	13.3
88	8.4	7.5	6.9	6.7	5.6	48	11.7
96	7.9	7.0	6.5	6.3	5.2	56	10.2
104	7.3	6.6	6.2	6.0	4.9	64	9.0
112	6.8	6.2	5.9	5.7	4.8	72	8.2
120	6.3	5.9	5.7	5.2	4.6	80	7.4
128	5.8	5.6	5.4	5.0	4.4	88	6.6
136	5.4	5.1	5.1	4.7	4.4	96	5.9
144	4.9	4.9	5.1	4.6	4.4	104	5.4
152	4.3	4.6	2.6	4.4	-	112	4.8
160	3.6	3.9	-	4.0	-		

 *161.1 ft **137.5 ft

19,000 lb  **26.6 ft x 23.6 ft** **360°** **ASME B30.5**

164.4 ft 

ft	26.3 ft				
	0°	0°	0°	20°	40°
	32.8 ft				
	0°	20°*	40°*	0°	0°
1,000 lb					
56	5.5	-	-	-	-
64	5.5	-	-	-	-
72	5.5	-	-	-	-
80	5.0	5.7	-	-	-
88	3.3	5.6	-	-	-
96	2.0	4.6	-	-	-
104	-	3.3	4.9	-	-
112	-	-	3.7	-	-
120	-	-	2.6	-	-

148.6 ft 

ft	26.3 ft				
	0°	0°	0°	20°	40°
	32.8 ft				
	0°	20°	40°	0°	0°**
1,000 lb					
48	6.8	-	-	-	-
56	6.8	-	-	-	-
64	6.8	-	-	-	-
72	6.8	-	-	-	-
80	6.4	6.8	-	-	-
88	4.8	6.4	-	6.0	-
96	3.5	5.5	6.0	5.5	-
104	2.3	4.1	5.2	4.2	4.9
112	-	3.0	4.6	3.0	4.8
120	-	-	3.3	-	4.2
128	-	-	2.3	-	3.1
136	-	-	-	-	2.0





95.5 ft 





ft	26.3 ft				
	0°	0°	0°	20°	40°
	32.8 ft				
	0°	20°	40°	0°	0°
1,000 lb					
28	13.4	-	-	-	-
32	13.4	-	-	-	-
36	13.2	-	-	-	-
40	12.9	-	-	-	-
48	12.1	-	-	-	-
56	11.3	10.0	-	-	-
64	10.5	9.2	-	8.3	-
72	9.9	8.6	7.7	7.7	-
80	9.1	8.1	7.2	7.2	-
88	8.2	7.5	6.9	6.7	5.6
96	7.3	7.0	6.5	6.3	5.2
104	6.1	6.5	6.2	6.0	4.9
112	5.0	5.9	5.9	5.5	4.8
120	4.0	5.0	5.4	5.1	4.6
128	3.1	4.0	4.6	4.2	4.3
136	2.3	3.0	3.5	3.3	3.5
144	1.6	2.2	2.7	2.5	2.5





39.4 ft 





ft	26.3 ft				
	0°	0°	0°	20°	40°
	32.8 ft				
	0°	20°	40°	0°	0°
1,000 lb					
14	17.9	-	-	-	-
16	17.9	-	-	-	-
18	17.8	-	-	-	-
20	17.6	-	-	-	-
24	16.8	-	-	-	-
28	16.0	-	-	-	-
32	15.2	-	-	-	-
36	14.2	-	-	-	-
40	13.3	12.0	-	-	-
48	11.7	10.5	-	9.6	-
56	10.2	9.4	8.7	8.6	-
64	9.0	8.4	7.9	7.7	-
72	8.2	7.5	7.1	7.1	-
80	7.4	6.7	6.5	6.3	5.6
88	6.6	6.2	6.1	5.8	5.2
96	5.9	5.7	5.7	5.2	4.9
104	5.4	5.3	-	4.9	4.7
112	4.8	-	-	-	-

 ***161.1 ft** ****137.5 ft**

13,400 lb		26.6 ft x 23.6 ft		360°		ASME B30.5	
 164.4 ft							
 		26.3 ft		0° 0° 0° 20° 40°			
 		32.8 ft		0° 20°* 40°* 0° 0°			
ft		1,000 lb					
56	5.5	-	-	-	-	-	-
64	5.5	-	-	-	-	-	-
72	5.1	-	-	-	-	-	-
80	3.3	5.6	-	-	-	-	-
88	-	4.5	-	-	-	-	-
96	-	3.1	-	-	-	-	-
104	-	1.9	3.7	-	-	-	-
112	-	-	2.6	-	-	-	-

 148.6 ft							
 		26.3 ft		0° 0° 0° 20° 40°			
 		32.8 ft		0° 20° 40° 0° 0°**			
ft		1,000 lb					
48	6.8	-	-	-	-	-	-
56	6.8	-	-	-	-	-	-
64	6.8	-	-	-	-	-	-
72	6.6	-	-	-	-	-	-
80	4.8	6.6	-	-	-	-	-
88	3.3	5.6	-	5.6	-	-	-
96	2.1	4.2	5.6	4.4	-	-	-
104	-	2.8	4.6	3.0	4.9	-	-
112	-	-	3.2	-	4.3	-	-
120	-	-	2.2	-	3.1	-	-
128	-	-	-	-	2.0	-	-

 95.5 ft							
 		26.3 ft		0° 0° 0° 20° 40°			
 		32.8 ft		0° 20° 40° 0° 0°			
ft		1,000 lb					
28	13.4	-	-	-	-	-	-
32	13.4	-	-	-	-	-	-
36	13.2	-	-	-	-	-	-
40	12.9	-	-	-	-	-	-
48	12.1	-	-	-	-	-	-
56	11.3	10.0	-	-	-	-	-
64	10.5	9.2	-	8.3	-	-	-
72	9.9	8.6	7.7	7.7	-	-	-
80	8.8	8.1	7.2	7.2	-	-	-
88	7.7	7.5	6.9	6.7	5.6	-	-
96	6.4	6.9	6.5	6.3	5.2	-	-
104	5.0	6.2	6.0	5.8	4.9	-	-
112	3.9	5.0	5.7	5.2	4.8	-	-
120	2.9	3.9	4.8	4.2	4.5	-	-
128	2.2	3.0	3.7	3.2	3.7	-	-
136	-	2.2	2.7	2.4	2.7	-	-
144	-	-	1.8	1.6	1.8	-	-

 39.4 ft							
 		26.3 ft		0° 0° 0° 20° 40°			
 		32.8 ft		0° 20° 40° 0° 0°			
ft		1,000 lb					
14	17.9	-	-	-	-	-	-
16	17.9	-	-	-	-	-	-
18	17.8	-	-	-	-	-	-
20	17.6	-	-	-	-	-	-
24	16.8	-	-	-	-	-	-
28	16.0	-	-	-	-	-	-
32	15.2	-	-	-	-	-	-
36	14.2	-	-	-	-	-	-
40	13.3	12.0	-	-	-	-	-
48	11.7	10.5	-	9.6	-	-	-
56	10.2	9.4	8.7	8.6	-	-	-
64	9.0	8.4	7.9	7.7	-	-	-
72	8.2	7.5	7.1	7.1	-	-	-
80	7.4	6.7	6.5	6.3	5.6	-	-
88	6.6	6.2	6.1	5.8	5.2	-	-
96	5.9	5.7	5.7	5.2	4.9	-	-
104	5.4	5.3	-	4.9	4.7	-	-
112	4.8	-	-	-	-	-	-

 *161.1 ft **137.5 ft

9,500 lb		26.6 ft x 23.6 ft					360°		ASME B30.5				
164.4 ft							148.6 ft						
		26.3 ft							26.3 ft				
		32.8 ft							32.8 ft				
		1,000 lb							1,000 lb				
ft		0°	0°	0°	20°	40°	ft		0°	0°	0°	20°	40°
56		5.5	-	-	-	-	48		6.8	-	-	-	-
64		5.3	-	-	-	-	56		6.8	-	-	-	-
72		3.8	-	-	-	-	64		6.6	-	-	-	-
80		-	5.2	-	-	-	72		5.3	-	-	-	-
88		-	3.4	-	-	-	80		3.5	6.3	-	-	-
96		-	2.1	-	-	-	88		2.2	4.5	-	4.7	-
104		-	-	2.8	-	-	96		-	3.1	5.0	3.3	-
							104		-	1.9	3.7	1.9	4.7
							112		-	-	2.4	-	3.5
							120		-	-	-	-	2.2





95.5 ft		26.3 ft					360°		ASME B30.5				
		32.8 ft							32.8 ft				
		1,000 lb							1,000 lb				
ft		0°	0°	0°	20°	40°	ft		0°	0°	0°	20°	40°
28		13.4	-	-	-	-	14		17.9	-	-	-	-
32		13.4	-	-	-	-	16		17.9	-	-	-	-
36		13.2	-	-	-	-	18		17.8	-	-	-	-
40		12.9	-	-	-	-	20		17.6	-	-	-	-
48		12.1	-	-	-	-	24		16.8	-	-	-	-
56		11.3	10.0	-	-	-	28		16.0	-	-	-	-
64		10.5	9.2	-	8.3	-	32		15.2	-	-	-	-
72		9.5	8.6	7.7	7.7	-	36		14.2	-	-	-	-
80		8.3	8.1	7.2	7.2	-	40		13.3	12.0	-	-	-
88		6.7	7.3	6.9	6.7	5.6	48		11.7	10.5	-	9.6	-
96		5.3	6.6	6.5	6.3	5.2	56		10.2	9.4	8.7	8.6	-
104		4.1	5.5	6.0	5.6	4.9	64		9.0	8.4	7.9	7.7	-
112		3.0	4.3	5.2	4.6	4.8	72		8.2	7.5	7.1	7.1	-
120		2.2	3.3	3.9	3.5	4.2	80		7.4	6.7	6.5	6.3	5.6
128		-	2.3	3.0	2.5	3.1	88		6.6	6.2	6.1	5.8	5.2
136		-	-	2.2	1.7	2.0	96		5.9	5.7	5.7	5.2	4.9
							104		5.4	5.3	-	4.9	4.7
							112		4.8	-	-	-	-

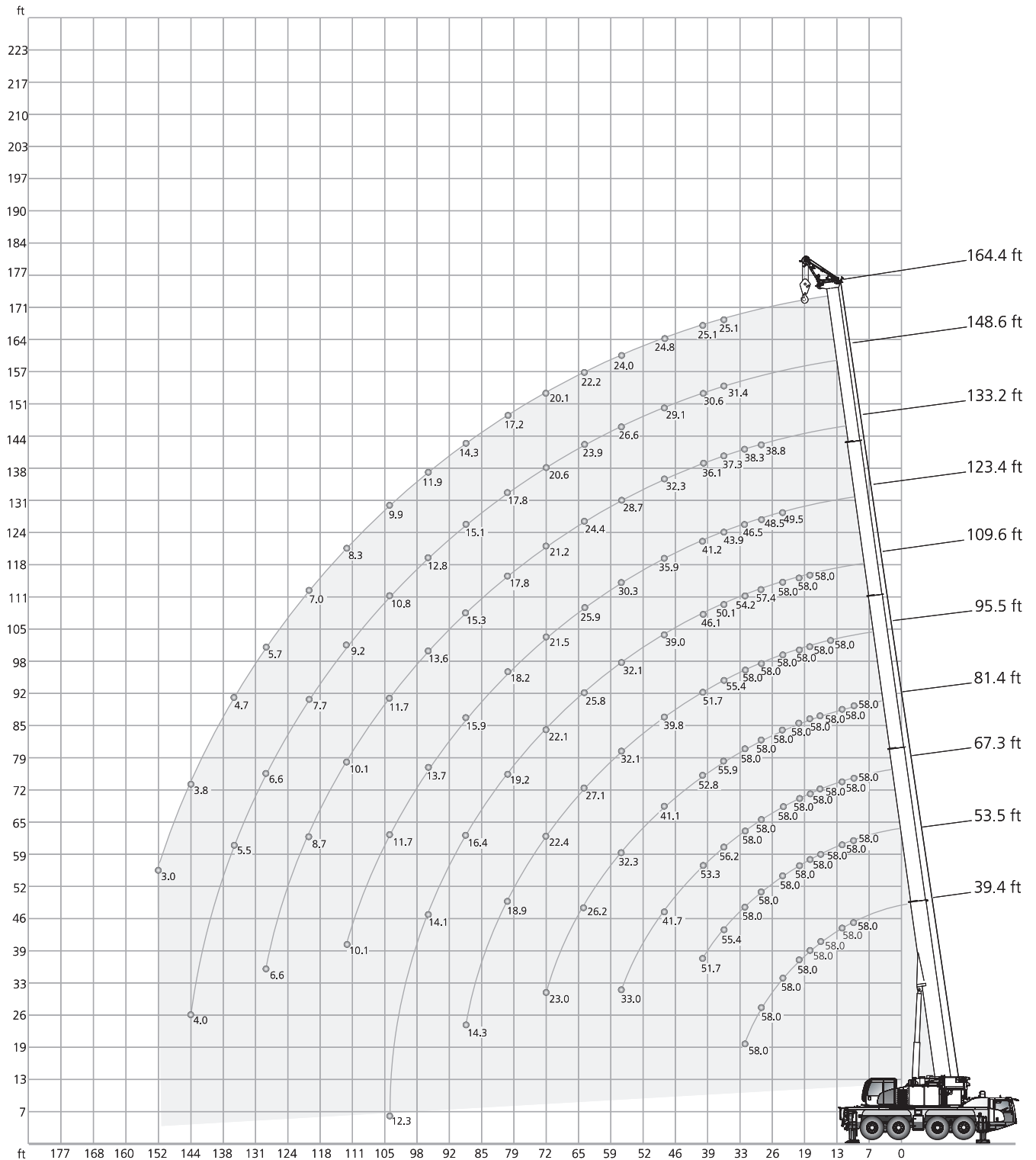
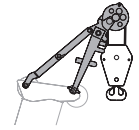



 *161.1 ft **137.5 ft





A large rectangular area with horizontal lines, intended for taking notes.







54,000 lb		26.6 ft x 23.6 ft										360°		ASME B30.5	
		(ft)													
		39.4	53.5	67.3	81.4	95.5	109.6	123.4	133.2	148.6	164.4				
ft		1,000 lb										ft			
10		58.0	58.0	58.0	58.0	-	-	-	-	-	-	-	-	-	10
12		58.0	58.0	58.0	58.0	-	-	-	-	-	-	-	-	-	12
14		58.0	58.0	58.0	58.0	58.0	-	-	-	-	-	-	-	-	14
16		58.0	58.0	58.0	58.0	58.0	-	-	-	-	-	-	-	-	16
18		58.0	58.0	58.0	58.0	58.0	58.0	-	-	-	-	-	-	-	18
20		58.0	58.0	58.0	58.0	58.0	58.0	-	-	-	-	-	-	-	20
24		58.0	58.0	58.0	58.0	58.0	58.0	49.5	-	-	-	-	-	-	24
28		58.0	58.0	58.0	58.0	58.0	57.4	48.5	38.8	-	-	-	-	-	28
32		58.0	58.0	58.0	58.0	58.0	54.2	46.5	38.3	-	-	-	-	-	32
36		-	55.4	56.2	55.9	55.4	50.1	43.9	37.3	31.4	25.1	-	-	-	36
40		-	51.7	53.3	52.8	51.7	46.1	41.2	36.1	30.6	25.1	-	-	-	40
48		-	-	41.7	41.1	39.8	39.0	35.9	32.3	29.1	24.8	-	-	-	48
56		-	-	33.0	32.3	32.1	32.1	30.3	28.7	26.6	24.0	-	-	-	56
64		-	-	16.5	26.2	27.1	25.8	25.9	24.4	23.9	22.2	-	-	-	64
72		-	-	-	23.0	22.4	22.1	21.5	21.2	20.6	20.1	-	-	-	72
80		-	-	-	-	18.9	19.2	18.2	17.8	17.8	17.2	-	-	-	80
88		-	-	-	-	14.3	16.4	15.9	15.3	15.1	14.3	-	-	-	88
96		-	-	-	-	-	14.1	13.7	13.6	12.8	11.9	-	-	-	96
104		-	-	-	-	-	12.3	11.7	11.7	10.8	9.9	-	-	-	104
112		-	-	-	-	-	-	10.1	10.1	9.2	8.3	-	-	-	112
120		-	-	-	-	-	-	-	8.7	7.7	7.0	-	-	-	120
128		-	-	-	-	-	-	-	6.6	6.6	5.7	-	-	-	128
136		-	-	-	-	-	-	-	-	5.5	4.7	-	-	-	136
144		-	-	-	-	-	-	-	-	4.0	3.8	-	-	-	144
152		-	-	-	-	-	-	-	-	-	3.0	-	-	-	152

 42,500 lb		 26.6 ft x 23.6 ft		360°		ASME B30.5					
 ft	 39.4	53.5	67.3	81.4	(ft) 95.5	109.6	123.4	133.2	148.6	164.4	 ft
1,000 lb											
10	58.0	58.0	58.0	58.0	-	-	-	-	-	-	10
12	58.0	58.0	58.0	58.0	-	-	-	-	-	-	12
14	58.0	58.0	58.0	58.0	58.0	-	-	-	-	-	14
16	58.0	58.0	58.0	58.0	58.0	-	-	-	-	-	16
18	58.0	58.0	58.0	58.0	58.0	58.0	-	-	-	-	18
20	58.0	58.0	58.0	58.0	58.0	58.0	-	-	-	-	20
24	58.0	58.0	58.0	58.0	58.0	58.0	49.5	-	-	-	24
28	58.0	58.0	58.0	58.0	58.0	57.4	48.5	38.8	-	-	28
32	58.0	58.0	58.0	58.0	58.0	58.0	54.2	46.5	38.3	-	32
36	-	52.9	53.7	53.5	52.7	49.9	43.9	37.3	31.4	25.1	36
40	-	47.7	48.1	47.7	46.2	45.3	41.1	36.1	30.6	25.1	40
48	-	-	36.3	35.8	35.7	35.4	33.8	32.0	29.1	24.8	48
56	-	-	28.5	28.5	28.9	27.8	27.9	26.8	26.0	24.0	56
64	-	-	16.5	23.9	23.3	23.5	22.7	22.1	21.9	21.2	64
72	-	-	-	19.7	19.7	19.3	18.8	19.0	18.2	17.3	72
80	-	-	-	-	16.8	16.3	15.9	15.9	15.0	14.1	80
88	-	-	-	-	13.1	13.8	13.3	13.4	12.4	11.6	88
96	-	-	-	-	-	11.8	11.2	11.2	10.3	9.5	96
104	-	-	-	-	-	10.1	9.5	9.5	8.6	7.7	104
112	-	-	-	-	-	-	8.1	8.1	7.0	6.3	112
120	-	-	-	-	-	-	-	6.8	5.9	5.0	120
128	-	-	-	-	-	-	-	4.7	4.7	4.0	128
136	-	-	-	-	-	-	-	-	3.9	3.0	136
144	-	-	-	-	-	-	-	-	2.2	2.2	144

 19,000 lb		 26.6 ft x 23.6 ft		360°		ASME B30.5					
 ft	 39.4	53.5	67.3	81.4	(ft) 95.5	109.6	123.4	133.2	148.6	164.4	 ft
1,000 lb											
10	58.0	58.0	58.0	58.0	-	-	-	-	-	-	10
12	58.0	58.0	58.0	58.0	-	-	-	-	-	-	12
14	58.0	58.0	58.0	58.0	58.0	-	-	-	-	-	14
16	58.0	58.0	58.0	58.0	58.0	-	-	-	-	-	16
18	58.0	58.0	58.0	58.0	58.0	58.0	-	-	-	-	18
20	58.0	58.0	58.0	58.0	58.0	58.0	-	-	-	-	20
24	58.0	58.0	58.0	58.0	58.0	57.6	49.5	-	-	-	24
28	56.0	57.5	57.9	57.0	55.4	52.8	47.5	38.8	-	-	28
32	47.1	50.0	50.4	49.6	48.5	45.7	42.7	38.3	-	-	32
36	-	41.5	41.9	41.3	42.0	39.6	38.0	34.3	31.1	25.1	36
40	-	34.3	34.8	35.8	35.2	35.4	33.9	31.5	29.4	24.9	40
48	-	-	26.5	26.7	26.9	26.3	25.8	25.7	23.7	21.8	48
56	-	-	20.6	20.7	20.7	20.4	19.8	19.8	18.6	17.1	56
64	-	-	16.1	16.6	16.6	16.2	15.5	15.5	14.6	13.1	64
72	-	-	-	13.3	13.3	12.9	12.2	12.2	11.3	10.0	72
80	-	-	-	-	10.9	10.2	9.6	9.8	8.7	7.6	80
88	-	-	-	-	8.8	8.3	7.6	7.7	6.7	5.8	88
96	-	-	-	-	-	6.7	6.0	6.0	5.1	4.2	96
104	-	-	-	-	-	5.2	4.6	4.8	3.7	3.0	104
112	-	-	-	-	-	-	3.5	3.7	2.6	-	112
120	-	-	-	-	-	-	-	2.7	-	-	120

 13,400 lb		 26.6 ft x 23.6 ft		360°		ASME B30.5						
		39.4	53.5	67.3	81.4	(ft) 95.5	109.6	123.4	133.2	148.6	164.4	
ft	1,000 lb										ft	
10	58.0	58.0	58.0	58.0	58.0	-	-	-	-	-	-	10
12	58.0	58.0	58.0	58.0	58.0	-	-	-	-	-	-	12
14	58.0	58.0	58.0	58.0	58.0	58.0	-	-	-	-	-	14
16	58.0	58.0	58.0	58.0	58.0	58.0	-	-	-	-	-	16
18	58.0	58.0	58.0	58.0	58.0	58.0	58.0	-	-	-	-	18
20	58.0	58.0	58.0	58.0	58.0	58.0	58.0	-	-	-	-	20
24	58.0	58.0	58.0	58.0	58.0	57.6	56.1	49.4	-	-	-	24
28	53.4	54.9	55.3	54.4	52.7	49.6	45.1	38.8	31.0	-	-	28
32	42.9	45.8	46.3	45.7	45.4	42.6	40.5	36.2	30.7	-	-	32
36	-	37.9	38.4	38.8	38.5	37.5	35.7	33.4	29.5	25.1	-	36
40	-	31.0	32.6	32.8	32.8	32.1	30.7	30.1	27.4	24.7	-	40
48	-	-	24.1	24.2	24.3	23.9	23.3	23.0	20.9	19.0	-	48
56	-	-	18.5	18.8	18.8	18.3	17.7	17.7	16.1	14.5	-	56
64	-	-	14.6	14.6	14.8	14.2	13.5	13.7	12.4	10.8	-	64
72	-	-	-	11.7	11.7	11.1	10.4	10.4	9.5	8.0	-	72
80	-	-	-	-	9.4	8.7	8.1	8.3	7.2	6.1	-	80
88	-	-	-	-	7.4	7.0	6.3	6.3	5.4	4.3	-	88
96	-	-	-	-	-	5.3	4.8	4.8	3.8	3.0	-	96
104	-	-	-	-	-	4.1	3.5	3.5	2.6	1.7	-	104
112	-	-	-	-	-	-	2.4	2.6	-	-	-	112

 9,500 lb		 26.6 ft x 23.6 ft		360°		ASME B30.5						
		39.4	53.5	67.3	81.4	(ft) 95.5	109.6	123.4	133.2	148.6	164.4	
ft	1,000 lb										ft	
10	58.0	58.0	58.0	58.0	58.0	-	-	-	-	-	-	10
12	58.0	58.0	58.0	58.0	58.0	-	-	-	-	-	-	12
14	58.0	58.0	58.0	58.0	58.0	58.0	-	-	-	-	-	14
16	58.0	58.0	58.0	58.0	58.0	58.0	-	-	-	-	-	16
18	58.0	58.0	58.0	58.0	58.0	58.0	58.0	-	-	-	-	18
20	58.0	58.0	58.0	58.0	58.0	58.0	58.0	-	-	-	-	20
24	57.8	58.0	58.0	57.5	56.7	54.9	48.2	38.0	-	-	-	24
28	51.2	53.0	53.4	52.0	50.2	46.9	43.4	38.0	31.0	-	-	28
32	39.7	42.6	43.1	43.5	42.3	40.6	38.3	36.2	30.7	-	-	32
36	-	35.2	35.6	36.9	35.7	35.1	33.0	32.1	28.2	24.3	-	36
40	-	28.9	30.2	30.4	30.4	30.0	28.1	27.4	25.0	22.9	-	40
48	-	-	22.2	22.6	22.7	22.0	21.2	20.9	18.7	16.9	-	48
56	-	-	17.0	17.1	17.2	16.5	16.0	16.0	14.2	12.7	-	56
64	-	-	13.2	13.3	13.3	12.6	12.2	12.2	10.8	9.3	-	64
72	-	-	-	10.4	10.4	9.8	9.1	9.1	8.0	6.7	-	72
80	-	-	-	-	8.1	7.6	7.0	7.0	5.9	4.6	-	80
88	-	-	-	-	6.4	5.8	5.2	5.2	4.3	3.1	-	88
96	-	-	-	-	-	4.4	3.7	3.9	2.8	1.9	-	96
104	-	-	-	-	-	3.2	2.6	2.6	1.7	-	-	104

Notes to Lifting Capacity

Ratings are in compliance with ASME B30.5. Lifting capacities do not exceed 85 % of tipping load.

Weight of hook blocks and slings is part of the load, and is to be deducted from the capacity ratings. Consult operation manual for further details.

Note: Data published herein is intended as a guide only and shall not be construed to warrant applicability for lifting purposes. Crane operation is subject to the computer charts and operation manual both supplied with the crane.

Basic machine

Equipment carrier

Engine 340-5	Mercedes-Benz OM471; Diesel engine; Output 340 kW / 1700 1/min (462 HP), torque 2200 Nm / 1000 1/min; The engine complies with EU Stage V / Tier 4F; Exhaust system complete stainless steel with SCR catalyzer.
Fuel tank	Fuel tank 108 gallons (no RME / biodiesel); 11 gallons AdBlue tank.
Transmission G230-12	Mercedes-Benz G230-12; Automated gearbox; 12 forward speeds and 2 reverse; 2-stage transfer case with switchable longitudinal lock.
Axles 8 x 4 x 8	8 x 4 x 8; Four axles, axles 1 and 4 are driven and equipped with selectable transverse lock; All axles steered.
Suspension	Hydropneumatic suspension with axle load compensation; Hydraulically lockable; Manual or automatic levelling alternatively.
Steering	Dual circuit hydro servocom steering with emergency steering pump; Active rear axle steering (axles 3 and 4) with 6 different steering programs.
Brakes	Pneumatic dual circuit service brake with antilock system, acting on all wheels; Disc brakes; Additional exhaust brake and constant throttle valve; Spring-loaded parking brake; Incl. ABS.
Tires size 385/95 R25 (14.00R25)	Tires size 385/95 R25 (14.00R25); Steel rims 9,50-25/1,7".
Cab 2550	Type 8.4 ft; Adjustable driver seat, armrests and pneumatic suspension; Steering wheel height and tilt adjustable; Power door windows; Tinted glass; Radio; Seat heating.
Heating engine-dependent	Engine-dependent warm water heating with 12 kW heating power.
Aircondition	Aircondition for carrier cab, 7 kW rated cooling power.
Drive lights	Including low beam, upper beam, daytime running lights, fog lights and cornering lights.
Outriggers	H-4-Point design; Vertical and horizontal movement fully hydraulic; Manual or automatic levelling alternatively on both sides of carrier; 4 outrigger bases.
Outrigger pads 028	4 outrigger pads A = 0.92 ft ² with transport position at vertical cylinder.
Outrigger basis monitoring	Individual monitoring of horizontal stroke; Deviation warning in cab.
Outrigger load indicator	The outrigger load is indicated in the operator cab and the outrigger control box.
Electronic immobilizer system	Prevents uncontrolled carrier mobilization; Incl. 5 ignition keys.
Pneumatic tire filling plug	Pneumatic system adapter for inflating tires makes it possible for operators to inflate tires by themselves.
Contour safety marking	Continuous, yellow reflecting bands at carrier sides and tail.

Equipment superstructure

Engine 129-5	Mercedes-Benz OM934; Diesel engine; Output 129 kW / 2200 1/min (175 HP), torque 750 Nm / 1200 1/min; The engine complies with EU Stage V / Tier 4F; Exhaust system complete stainless steel with SCR catalyzer.
Fuel tank	Fuel tank 53 gallons Diesel (no RME/ Biodiesel); 6.6 gallons AdBlue tank.
Telescopic boom HA60	39.4 - 194.9 ft; Single cylinder telescoping system, automatic telescoping; Attachments for all equipment and extensions; 5 sheaves integrated in boom head for max. capacity of 142,200 lb.
Boom luffing	Single luffing cylinder with automatic lowering brake valve.
Rotary drive	Single slewing gear unit with spring-loaded multi-disc brake.
H1	Hoist with spring-loaded multi-disc brake; Resolver (hoist rotation indicator); Incl. hoist monitoring.
Counterweight 42,500 lb	42,500 lb, 5 pieces (SPECIAL 4 pieces); Automatic rigging system.
Control system	Enabling 4 simultaneous working movements; Electric pilot controls via 2 two-axis joysticks.
Operator aids	IC-1, with integrated load moment indicator acc. EN13000; Colour display; Displaying of current operating conditions, load charts, fault indicator; Signal lights indicating LMI-load; Crane data logger.
Working range limiter	Displaying and programmability of the work range limits by IC-1.
Hook height indication	Displaying and programmability of the hook height H1 by IC-1.
Cab 875	Type 2.9 ft; Tilt variable 16°; Fold-out front window; Extendable side, front pedestal; Handrails; Tinted safety glass; Pull-down sun visor; Radio; Seat heating.
Heating engine-dependent	Engine-dependent warm water heating with 5 kW heating power.
Aircondition	Aircondition in crane cab with 5 kW rated cooling power.
Anemometer	Removable, to be used with all extensions.

Additional equipment

Carrier

Engine 340 ECE R96	Mercedes-Benz OM471; Diesel engine; Output 340 kW / 1700 1/min (462 HP), torque 2200 Nm / 1000 1/min; The engine complies with ECE R96 (equivalent to former European regulation EU Stage IIIA / Tier 3); Exhaust system complete stainless steel with spark arrester.
Axles 8 x 6 x 8	8 x 6 x 8; Four axles, axles 1, 3 and 4 are driven and equipped with selectable transverse lock; All axles steered.
Eddy-current brake	Eddy current brake (TELMA) to increase the braking power, especially when towing a trailer.

Superstructure

Engine 129 ECE R96	Mercedes-Benz OM934; Diesel engine; Output 129 kW / 2200 1/min (175 HP), torque 750 Nm / 1200 1/min; The engine complies with ECE R96 (equivalent to former European regulation EU Stage IIIA / Tier 3); Exhaust system complete stainless steel with spark arrester.
Telescopic boom HA50	39.4 - 164.4 ft; Single cylinder telescoping system, automatic telescoping; Attachments for all equipment and extensions; 5 sheaves integrated in boom head for max. capacity of 142,200 lb.
Heavy lift attachment 2. hoist (H2)	2 additional sheaves; Dis-/connectable; For total 7 sheaves at boom head; Max. capacity 176,400 lb. 2. hoist; Spring-loaded multi-disc brake; Resolver (hoist rotation indicator); Incl. quick couplings and transport rack; Self-rigging.
Additional counterweight 11,500 lb	Additional counterweight 11,500 lb; 2 pieces; For total 54,000 lb, 7 pieces (SPECIAL 6 pieces).
Load supervision camera	Camera mounted on main boom head to supervise the hook block and load from above; Incl. boom head light on boom head.

Handling

Remote control IC-1 Plus	Control of superstructure movements via wireless remote control. Smart crane control system for main boom operation enabling higher lifting capacities especially over outriggers. Enables safe use of the full capacity of the crane even in asymmetric outrigger configurations. Outriggers can be positioned independently. Capacity precalculation for +/- 30° slewing angle and radius area. In-cab lift simulation.
IC-1 Remote	IC-1 Remote, Demag telematic system.

Extensions

HAV10	32.8 ft; Swing-away jib, manual offset 20° / 40°; 1-sheave head; Incl. transport storage.
HAV19	62.3 ft; Double folding swing-away jib, manual offset 20°/40°; 1-sheave head; Incl. transport storage; Includes HAV 32.8 ft.
HAV-VA18	59.0 ft; Variable extension with swing-away jib, manual offset 20° / 40°; 1-sheave head; Incl. transport storage; Includes HAV 32.8 ft.
HAV-VA27	88.6 ft; Variable extension with double folding swing-away jib, manual offset 20° / 40°; 1-sheave head; Incl. transport storage; Includes HAV 32.8 ft, HAV 62.3 ft and HAV-VA 59.0 ft.
HAV-HY	Hydraulic, stepless offset 0°-40°, instead of the manual offset; Available for HAV 32.8 ft, HAV 62.3 ft, HAV-VA 59.0 ft and HAV-VA 88.6 ft.
MS (runner)	4.9 ft; Fixed assembly jib, 2-sheaves for max. capacity 58,700 lb; Incl. transport storage at boom head.

Hook Blocks

Hook block 100-7-18-D	100-7-18-D (1,650 lb); Hook block with ramshorn hook; white with red signal stripes.
Hook block 80-5-18-D	80-5-18-D (1,430 lb); Hook block with ramshorn hook; white with red signal stripes.
Hook block 50-3B-18-D-Vario	50-3B-18-D (1,320 lb); Hook block with adjustable ballast and ramshorn hook, variable usage as 1- and 3-sheave hook block; white with red signal stripes.
Hook block 50-3-18-D	50-3-18-D (1,320 lb); Hook block with ramshorn hook; white with red signal stripes.
Hook block 20-1-18-E	20-1-18-E (662 lb); Hook block with single hook; white with red signal stripes.
Hook 8-0V-E-170	8-0V-E (375 lb); Single hook with vertical swivel; red.

Further additional equipment on request!

Weight data may deviate from posted values based on road / travel configuration, equipment configuration, and component weight tolerances.

December 2020. Product specifications and prices are subject to change without notice or obligation. The photographs and/or drawings in this document are for illustrative purposes only. Refer to the appropriate Operator's Manual for instructions on the proper use of this equipment. Failure to follow the corresponding Operator's Manual when using our equipment or to otherwise act responsibly may result in serious injury or death. The only warranty applicable to our equipment is the standard written warranty applicable to the particular product and sale and Tadano makes no other warranty, express or implied. All rights reserved. Products and services listed may be trademarks, service marks or trade-names of Tadano Ltd.

© Tadano Demag GmbH 2020. Tadano and Demag are trademarks of or licensed by Tadano Ltd. or its subsidiaries.



Tadano Demag GmbH
Europa Allee 2
66482 Zweibrücken
Germany
T +49 6332 830

info.demag@tadano.com
www.demagmobilecranes.com



Tadano Ltd. (International Division)
4-12, Kamezawa 2-chome
Sumida-ku Tokyo 130-0014, Japan
E info@tadano.com T 81-3-3621-7750
www.tadano.com